

Standard valves to ISO 5599-1



Festo core product range
Covers 80% of your automation tasks

Worldwide:

Always in stock

Superb:

Festo quality at an attractive price

Easy:

Reduces procurement and storing complexity



Ready for dispatch from the Festo factory in 24 hours
Held in stock in 13 service centres worldwide
More than 2200 products



Ready for dispatch in 5 days maximum from stock
Assembled for you in 4 service centres worldwide
Up to 6 x 10¹² variants per product series

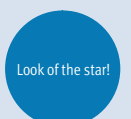

Standard valves to ISO 5599-1

Key features

FESTO

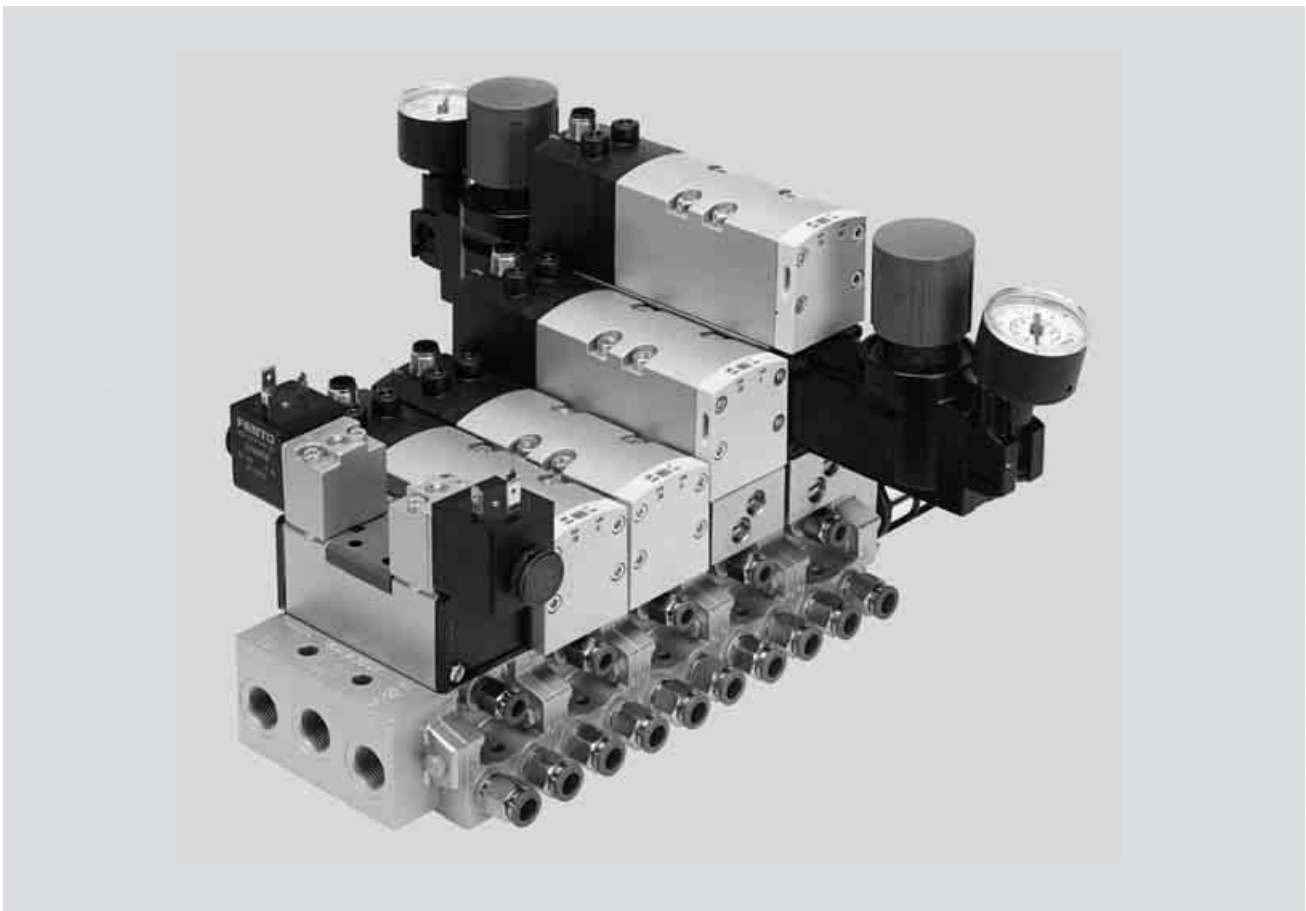

Innovative

- High-performance valves in a sturdy metal housing
- Individual electrical connection via square plug sockets or centrally for each valve via round plug sockets
- Valve replacement under pressure possible using vertical pressure shut-off plate
- Reverse operation
- Vacuum operation

Versatile

- Modular system offering a range of configuration options
- Easy to convert or extend at a later date
- Integration of innovative function modules possible
 - Pressure regulator plate
 - Flow control plate
 - Vertical pressure shut-off plate
 - Vertical supply plate
- Vertical supply plates permit a flexible air supply and variable pressure zones
- Wide range of valve functions
- Extensive operating voltage range from 12 V DC to 230 V AC

Reliable

- Sturdy and durable metal components
 - Valves
 - Horizontally linked sub-bases
 - Vertically stacked sub-bases
- Fast troubleshooting thanks to LED in the plug socket or illuminating seal
- LED integrated in the valve with the round plug variant
- Convenient servicing thanks to valves that can be replaced quickly and easily
- Manual override
- Durable thanks to tried-and-tested piston spool valves

Easy to install

- Plug-in pressure gauges on the pressure regulator plate

Standard valves to ISO 5599-1

Key features

FESTO

Individual manifold assembly

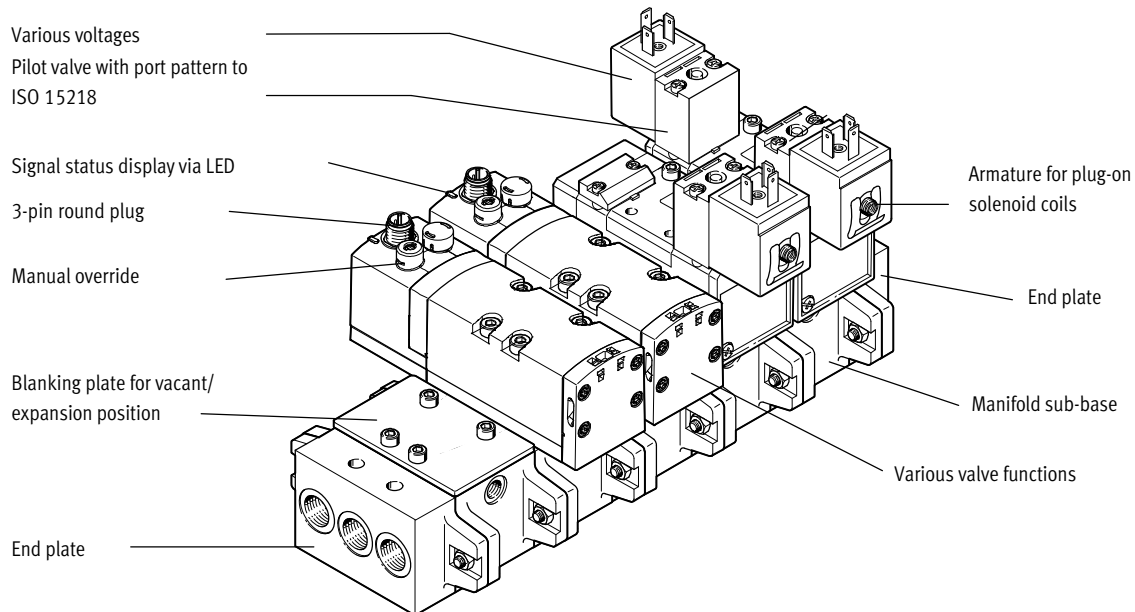

Equipment options

2x 2/2-way valve, single solenoid

- Normally closed
- Normally closed, vacuum operation possible at port 3 and 5

2x 3/2-way valve, single solenoid

- Normally open
- Normally closed
- 1x normally open, 1x normally closed
- Reverse operation possible (→ page 11)

5/2-way valve

- Single solenoid, mechanical or pneumatic spring return
- Double solenoid
- Double solenoid, with dominant signal at port 14

5/3-way valve

- Mid-position pressurised
- Mid-position closed
- Mid-position exhausted

Special characteristics

Operation with external pilot air supply

- For vacuum applications
- For working pressures lower than 3 bar
- For significant pressure fluctuations in the power section. Power section and pneumatic control section are isolated
- For heavily lubricated air in the power section
- For manifolds where the pressure zones are created via ducts 3 and 5 (not possible with 2x 3/2-way valves)
- For manifolds or pressure zones that are equipped with reversible 2x 3/2-way valves (valves on request)

Operation with internal pilot air supply

- For small pressure fluctuations in the power section
- For using pressure regulator plates in a vertical stacking construction, also in reverse operation
- As a low-cost solution

Reverse operation with compressed air supply via ducts 3 and 5

- Pressure zone separation via ducts 3 and 5
 - Example: Duct 3 vacuum, duct 5 ejector pulse
 - Example: Duct 3 high pressure for advancing the piston rod of a double-acting cylinder. Duct 5 low pressure for retracting the piston rod with low energy consumption
- 2x 3/2-way valves used as 5/4-way valve with controllable overlapping and pressure zone separation in the reversible variant

Reverse operation with a pressure regulator plate, compressed air supply via duct 1

- Reversible pressure regulator combined with a reversible 2x 3/2-way valve regulates outputs 2 and 4
 - AB regulator for outputs 2 and 4
 - A regulator for output 4
 - B regulator for output 2
- Reversible pressure regulators are in the control position immediately after the power supply is switched on
 - Adjustment possible at all times
 - Dynamic response characteristics
 - Reduced regulator load because the supply pressure is maintained when the valve is switched
 - Not exhausted via the regulator

Standard valves to ISO 5599-1

Key features

FESTO

Manifold assembly with vertical stacking

Solenoid valve with individual pilot valves and port pattern to ISO 15218, can be connected using square plug sockets

Solenoid valve with central round plug

Flow control plate for adjusting the speed of the drive

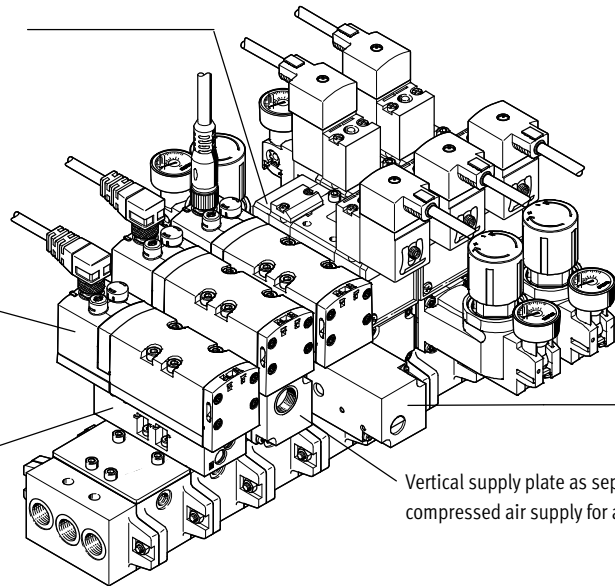

Pressure regulator for adjusting the force of the actuated drive

Vertical pressure shut-off plate for replacing solenoid valves during operation

Vertical supply plate as separate compressed air supply for a valve

Vertical stacking function

Pressure regulator

- Single variant to regulate the pressure in duct 4 or 2 or at 1
- Dual variant to regulate the pressure in ducts 4 and 2 individually
- As reversible version with internally replaced ducts 1 and 3/5
- With pressure gauge connection

Flow control plate

- Designed with two flow control valves, at which the exhaust air flow rate at ducts 5 or 3 can be adjusted.
- The movement of the drive is initiated and the required speed is set via the flow control plate using the manual override on the valve.

Vertical pressure shut-off plate

- Equipped with a switch via which the compressed air supply can be shut off. As a result, components mounted on the vertical pressure shut-off plate (e.g. a valve) can be replaced without switching off the overall air supply.
- If the control chain has a redundant connection, the cycle can continue even in the case of a cyclical control system.

Vertical supply plate

- As additional air supply for a valve
- Separates the valve from duct 1 of the manifold sub-base
- To supply an additional pressure zone

Individual connection with square plug

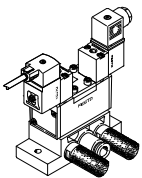

The directional control valve has a pilot control to ISO 15218. The solenoid coil plugged onto the armature can be chosen in different designs and operating voltages.

Individual connection with central round plug

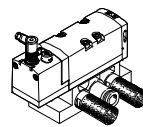

The electrical connection is established via a standardised M12 plug, 24 V DC (EN 61076-2-101).

Standard valves to ISO 5599-1

Key features

FESTO

Pressure regulator with one regulated duct

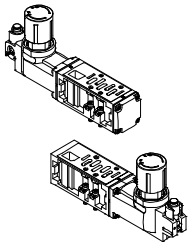

Versions

- For pressure regulation at the supply input (P), duct 1. Set pressure is identical for ducts 2 and 4
- For pressure regulation at the working port (A), duct 4
 - The pressure regulator for reverse operation is supplied via duct 1 of the manifold sub-base and supplies duct 5 on the valve
 - The valve is exhausted via duct 1 to ducts 3 and 5 of the manifold sub-base
- For pressure regulation at the working port (B), duct 2
 - In reverse operation duct 3 is supplied here

Pressure regulator with 2 regulated ducts

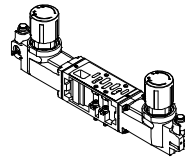

Versions

- For pressure regulation at the working ports (A and B), ducts 4 and 2
 - The pressure regulators for reverse operation are supplied via duct 1 of the manifold sub-base and supply ducts 5 and 3 on the valve
 - The directional control valve is exhausted via duct 1 to ducts 3 and 5 of the manifold sub-base

Vertical supply plate

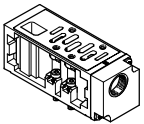

Versions

- As intermediate supply
 - For one valve
 - To supply an additional pressure zone
- Can be equipped with a valve

Flow control plate

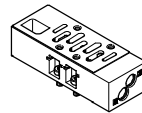

Versions

- Exhaust air flow control valves in ducts 3 and 5
 - The flow control plates act as supply air flow control valves for pressure zones that are created via ducts 3 and 5

Vertical pressure shut-off plate

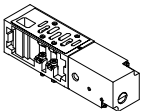

Versions

- A switch activated with a slotted screwdriver shuts off duct 1.
 - The flow control plates, pressure regulators or valves positioned above it can be replaced
 - Other components of the control chain such as drives, for example, can be replaced following venting via the valve

Pressure gauge



Version

- Plugs into the pressure regulators

Standard valves to ISO 5599-1

Key features



Port pattern on sub-base to ISO 5599-1

Width 42 mm (ISO 1)

Width 52 mm (ISO 2)

Width 65 mm (ISO 3)

Width 76 mm (ISO 4)

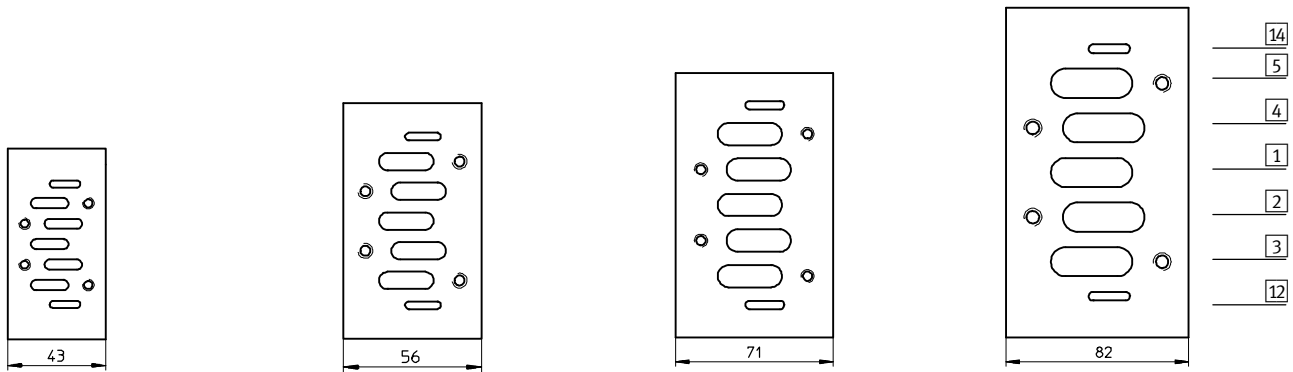

Sub-base port designations

Duct	Function	Description
14	Control section	Pilot air supply for pilot valves 12 and 14
5	Power section	Exhaust port
4	Power section	Working port
1	Power section	Working air supply port
2	Power section	Working port
3	Power section	Exhaust port
12	Control section	Exhaust port for pilot air supply

Conversion of pilot air exhaust

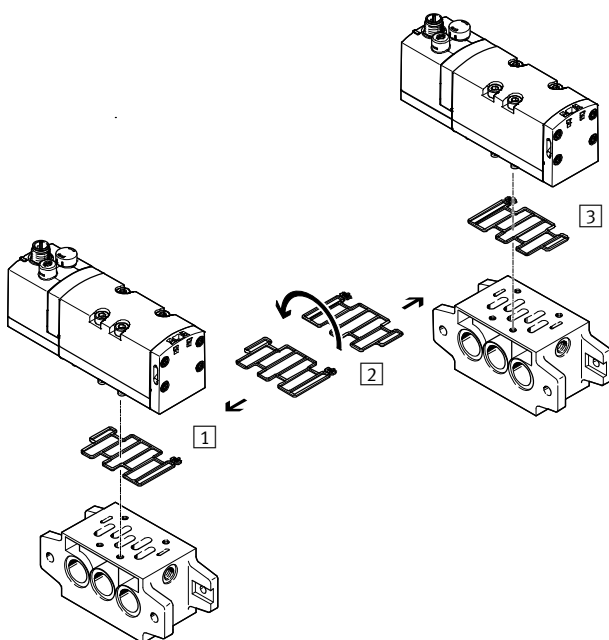

- 1 Ducted pilot air exhaust
- 2 Turning the seal by 180°
- 3 Unducted pilot air exhaust (delivery status)

VSVA manifold assemblies are supplied with unducted pilot air exhaust. By turning the seal between the valve and manifold block, exhaust air (pilot air) can be diverted into pilot duct 12 and can thus be contained and silenced (see illustration).





Standard valves to ISO 5599-1

Key features

Use of 2x 3/2-way valve as 5/4-way valve																			
Code	Symbol	Table of values	Equivalent circuit symbol	Function															
K		<table border="1"> <thead> <tr> <th>Y1</th> <th>Y2</th> <th>A</th> </tr> </thead> <tbody> <tr> <td>0</td> <td>0</td> <td></td> </tr> <tr> <td>0</td> <td>1</td> <td></td> </tr> <tr> <td>1</td> <td>0</td> <td></td> </tr> <tr> <td>1</td> <td>1</td> <td></td> </tr> </tbody> </table>	Y1	Y2	A	0	0		0	1		1	0		1	1			<ul style="list-style-type: none"> Normally exhausted The double-acting drive connected to ducts 2 and 4 is unpressurised when the valve is in the normal position and can be moved by an external force If there is a signal present at Y1(14) and Y2(12), there is pressure at ducts 2 and 4
Y1	Y2	A																	
0	0																		
0	1																		
1	0																		
1	1																		
		<table border="1"> <thead> <tr> <th>Y1</th> <th>Y2</th> <th>A</th> </tr> </thead> <tbody> <tr> <td>0</td> <td>0</td> <td></td> </tr> <tr> <td>0</td> <td>1</td> <td></td> </tr> <tr> <td>1</td> <td>0</td> <td></td> </tr> <tr> <td>1</td> <td>1</td> <td></td> </tr> </tbody> </table>	Y1	Y2	A	0	0		0	1		1	0		1	1			<ul style="list-style-type: none"> Normally closed (by combining valve code K and two piloted non-return valves) The piloted non-return valves connected to ducts 2 and 4 are unpressurised when the valve is in the normal position and the pressures in the drive close the non-return valves leak-tight The drive remains stationary when the forces are balanced Leakages can only occur via the drive seals If there is a signal present at Y1(14) and Y2(12), the same pressure is present at ducts 2 and 4
Y1	Y2	A																	
0	0																		
0	1																		
1	0																		
1	1																		
N		<table border="1"> <thead> <tr> <th>Y1</th> <th>Y2</th> <th>A</th> </tr> </thead> <tbody> <tr> <td>0</td> <td>0</td> <td></td> </tr> <tr> <td>0</td> <td>1</td> <td></td> </tr> <tr> <td>1</td> <td>0</td> <td></td> </tr> <tr> <td>1</td> <td>1</td> <td></td> </tr> </tbody> </table>	Y1	Y2	A	0	0		0	1		1	0		1	1			<ul style="list-style-type: none"> Normally open The double-acting drive connected to ducts 2 and 4 is supplied with the same pressure at both ends when the valve is in the normal position and remains stationary when the forces are balanced If there is a signal present at Y1(10) and Y2(10), ducts 2 and 4 are exhausted, the drive is unpressurised and can be moved by an external force
Y1	Y2	A																	
0	0																		
0	1																		
1	0																		
1	1																		
H		<table border="1"> <thead> <tr> <th>Y1</th> <th>Y2</th> <th>A</th> </tr> </thead> <tbody> <tr> <td>0</td> <td>0</td> <td></td> </tr> <tr> <td>0</td> <td>1</td> <td></td> </tr> <tr> <td>1</td> <td>0</td> <td></td> </tr> <tr> <td>1</td> <td>1</td> <td></td> </tr> </tbody> </table>	Y1	Y2	A	0	0		0	1		1	0		1	1			<ul style="list-style-type: none"> Normally open to duct 2 The double-acting drive connected to ducts 2 and 4 is supplied with pressure via duct 2 when the valve is in the normal position. Duct 4 is exhausted. When the system is in its initial position, the drive is thus in a clearly defined position, as would also be the case with a 5/2-way single solenoid valve. If there is a signal present at Y1(14) and Y2(10), duct 2 is exhausted and there is pressure at duct 4. The drive leaves the initial position A closed circuit can be created with this 2x 3/2-way valve by combining it with piloted non-return valves. However, this is then selected by an active signal at Y2(10).
Y1	Y2	A																	
0	0																		
0	1																		
1	0																		
1	1																		

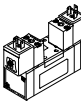
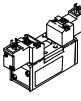

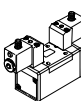

Standard valves to ISO 5599-1

Product range overview

Function	Type	Valve function	Flow rate	Operating voltage	→ Page/ Internet	
			Valve [l/min]			
Width 42 mm Working port G1/4	Valve with armature for solenoid coil MSN					
		MN1H-5/2	5/2-way single solenoid valve	1200	12 V DC, 24 V DC, 24 V AC, 110 V AC, 230 V AC	20
		JMN1	5/2-way double solenoid valve	1200		
		MN1H-5/3	5/3-way solenoid valve, mid-position valve	1200		
	Valve with armature for solenoid coil MSF					
		MFH-5/2	5/2-way single solenoid valve	1200	12 V DC, 24 V DC, 42 V DC, 24 V AC, 42 V AC, 48 V AC, 110 V AC, 120 V AC, 230 V AC, 240 V AC	32
		JMF	5/2-way double solenoid valve	1200		
		MFH-5/3	5/3-way solenoid valve, mid-position valve	1200		
	Valve with central plug M12, 3-pin					
		VSVA-B-T22	2x 2/2-way single solenoid valve	1300	24 V DC	44
		VSVA-B-T32	2x 3/2-way single solenoid valve	1100		
		VSVA-B-M52	5/2-way single solenoid valve	1300		
		VSVA-B-B52	5/2-way double solenoid valve	1300		
		VSVA-B-D52	5/2-way double solenoid valve	1300		
		VSVA-B-P53	5/3-way solenoid valve, mid-position valve	1300		
	Valve with individual plug M12					
		MDH-5/2	5/2-way single solenoid valve	1200	24 V DC, 42 V AC, 110 V AC, 230 V AC	61
		JMD	5/2-way double solenoid valve	1200		
		MDH-5/3	5/3-way solenoid valve, mid-position valve	1200		
	Pneumatic valve					
		VL-5/2	5/2-way pneumatic valve, monostable	1200	-	82
J		5/2-way pneumatic valve, bistable	1200			
VL-5/3		5/3-way pneumatic valve, mid-position valve	1200			

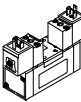
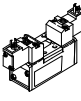
Standard valves to ISO 5599-1

Product range overview

Function	Type	Valve function	Flow rate	Operating voltage	→ Page/ Internet	
			Valve [l/min]			
Width 52 mm Working port G3/8	Valve with armature for solenoid coil MSN					
		MN1H-5/2	5/2-way single solenoid valve	2300	12 V DC, 24 V DC, 24 V AC, 110 V AC, 230 V AC	24
		JMN1	5/2-way double solenoid valve	2300		
		MN1H-5/3	5/3-way solenoid valve, mid-position valve	2300		
	Valve with armature for solenoid coil MSF					
		MFH-5/2	5/2-way single solenoid valve	2300	12 V DC, 24 V DC, 42 V DC, 24 V AC, 42 V AC, 48 V AC, 110 V AC, 120 V AC, 230 V AC, 240 V AC	36
		JMF	5/2-way double solenoid valve	2300		
		MFH-5/3	5/3-way solenoid valve, mid-position valve	2300		
	Valve with central plug M12, 3-pin					
		VSVA-B-T22	2x 2/2-way single solenoid valve	2800	24 V DC	52
		VSVA-B-T32	2x 3/2-way single solenoid valve	2200		
		VSVA-B-M52	5/2-way single solenoid valve	2800		
		VSVA-B-B52	5/2-way double solenoid valve	2800		
		VSVA-B-D52	5/2-way double solenoid valve	2800		
		VSVA-B-P53	5/3-way solenoid valve, mid-position valve	2700		
	Valve with individual plug M12					
		MDH-5/2	5/2-way single solenoid valve	2300	24 V DC, 42 V AC, 110 V AC, 230 V AC	66
		JMD	5/2-way double solenoid valve	2300		
		MDH-5/3	5/3-way solenoid valve, mid-position valve	2300		
	Pneumatic valve					
	VL-5/2	5/2-way pneumatic valve, monostable	2300	-	87	
	J	5/2-way pneumatic valve, bistable	2300			
	VL-5/3	5/3-way pneumatic valve, mid-position valve	2300			

Standard valves to ISO 5599-1

Product range overview



Function		Type	Valve function	Flow rate Valve	Operating voltage	→ Page/ Internet
				[l/min]		
Width 65 mm Working port G1/2	Valve with armature for solenoid coil MSN					
		MN1H-5/2	5/2-way single solenoid valve	4500	12 V DC, 24 V DC, 24 V AC, 110 V AC, 230 V AC	28
		JMN1	5/2-way double solenoid valve	4500		
		MN1H-5/3	5/3-way solenoid valve, mid-position valve	4000		
	Valve with armature for solenoid coil MSF					
		MFH-5/2	5/2-way single solenoid valve	4500	12 V DC, 24 V DC, 42 V DC, 24 V AC, 42 V AC, 48 V AC, 110 V AC, 120 V AC, 230 V AC, 240 V AC	40
		JMF	5/2-way double solenoid valve	4500		
		MFH-5/3	5/3-way solenoid valve, mid-position valve	4000		
	Valve with central plug M12, 4-pin					
		MEBH-5/2	5/2-way single solenoid valve	4500	24 V DC	57
		JMEB	5/2-way double solenoid valve	4500		
		MEBH-5/3	5/3-way solenoid valve, mid-position valve	4000		
	Valve with individual plug M12					
		MDH-5/2	5/2-way single solenoid valve	4500	24 V DC, 42 V AC, 110 V AC, 230 V AC	70
		JMD	5/2-way double solenoid valve	4500		
		MDH-5/3	5/3-way solenoid valve, mid-position valve	4000		
	Pneumatic valve					
		VL-5/2	5/2-way pneumatic valve, monostable	4500	-	92
		J	5/2-way pneumatic valve, bistable	4500		
		VL-5/3	5/3-way pneumatic valve, mid-position valve	4100		
Width 76 mm Working port G3/4	Valve with individual plug M12					
		MDH-5/2	5/2-way single solenoid valve	6000	24 V DC, 42 V AC, 110 V AC, 230 V AC	74
		JMD	5/2-way double solenoid valve	6000		
		MDH-5/3	5/3-way solenoid valve, mid-position valve	4800		
	Pneumatic valve					
		VL-5/2	5/2-way pneumatic valve, monostable	6000	-	97
		J	5/2-way pneumatic valve, bistable	6000		
VL-5/3		5/3-way pneumatic valve, mid-position valve	4800			

Standard valves to ISO 5599-1, central plug M12

Type codes for valves with round plug

		VSPA	-	B	-	T32F		-	A	Z	D	-	D1	-	1	R5	L
Valve																	
VSPA	Standard valves to ISO 5599-1																
Valve type																	
B	Sub-base valve																
Valve function																	
M52	5/2-way single solenoid valve																
B52	5/2-way double solenoid valve																
D52	5/2-way double solenoid valve, with dominant signal at 14																
P53U	5/3-way valve, mid-position pressurised																
P53E	5/3-way valve, mid-position exhausted																
P53C	5/3-way valve, mid-position closed																
T32U	2x 3/2-way valve, normally open																
T32C	2x 3/2-way valve, normally closed																
T32H	2x 3/2-way valve, 1x normally open, 1x normally closed																
T32F	2x 3/2-way valve, normally open, reverse operation																
T32N	2x 3/2-way valve, normally closed, reverse operation																
T32W	2x 3/2-way valve, 1x normally closed, 1x normally open, reverse operation																
T22C	2x 2/2-way valve, normally closed																
Additional function																	
	No additional function																
V	2x 2/2-way valve with vacuum operation																
Reset method																	
A	Pneumatic spring																
M	Mechanical spring																
Pilot air supply																	
Z	External																
	Internal																
Manual override																	
D	Non-detenting/detenting																
H	Non-detenting																
Pneumatic port (width)																	
D1	Width 42 mm/ISO size 1																
D2	Width 52 mm/ISO size 2																
Operating voltage																	
1	24 V DC																
Electrical connection																	
R5	Central plug M12x1																
Signal status display																	
L	LED (integrated)																

Standard valves to ISO 5599-1, solenoid coil MSN1

Type codes for valves with armature for solenoid coil MSN

MN1H – 5/2 – D-1 – – – C

Type

MN1H	Single solenoid
JMN1H	Double solenoid
JMN1DH	Double solenoid, with dominant signal at 14

Valve function

5/2	5/2-way valve
5/3G	5/3-way valve, mid-position closed
5/3E	5/3-way valve, mid-position exhausted
5/3B	5/3-way valve, mid-position pressurised

Pneumatic port (width)

D-1	Width 42 mm/ISO size 1
D-2	Width 52 mm/ISO size 2
D-3	Width 65 mm/ISO size 3

Reset method 5/2-way valve

	Pneumatic spring
FR	Mechanical spring

Pilot air supply

	Internal
S	External

Generation

C	C series
---	----------

Standard valves to ISO 5599-1, solenoid coil MSF

Type codes for valves with armature for solenoid coil MSF

MFH – 5/3G – D-1 – – – C – EX

Type

MFH	Single solenoid
JMFH	Double solenoid
JMFDH	Double solenoid, with dominant signal at 14

Valve function

5/2	5/2-way valve
5/3G	5/3-way valve, mid-position closed
5/3E	5/3-way valve, mid-position exhausted
5/3B	5/3-way valve, mid-position pressurised

Pneumatic port (width)

D-1	Width 42 mm/ISO size 1
D-2	Width 52 mm/ISO size 2
D-3	Width 65 mm/ISO size 3

Reset method 5/2-way valve

	Pneumatic spring
FR	Mechanical spring

Pilot air supply

	Internal
S	External

Generation

C	C series
---	----------

CE marking

	Without
EX	ATEX category → technical data

Standard valves to ISO 5599-1, central plug M12, 4-pin

Type codes for valves with central plug M12, 4-pin

MEBH – 5/3G – D-1 – – – C

Type

MEBH	Single solenoid
JMEBH	Double solenoid
JMEBDH	Double solenoid, with dominant signal at 14

Valve function

5/2	5/2-way valve
5/3G	5/3-way valve, mid-position closed
5/3E	5/3-way valve, mid-position exhausted
5/3B	5/3-way valve, mid-position pressurised

Pneumatic port (width)

D-3	Width 65 mm/ISO size 3
-----	------------------------

Electrical connection, operating voltage

ZSR	Central plug, round design, M12x1, 24 V DC
-----	--

Reset method 5/2-way valve

	Pneumatic spring
FR	Mechanical spring

Generation

C	C series
---	----------

Standard valves to ISO 5599-1, solenoid coil MD

Type codes for valves with individual plug M12

MDH – 5/3G – D-1 – – – – C

Type	
MDH	Single solenoid
JMDH	Double solenoid
JMDDH	Double solenoid, with dominant signal at 14

Valve function	
5/2	5/2-way valve
5/3G	5/3-way valve, mid-position closed
5/3E	5/3-way valve, mid-position exhausted
5/3B	5/3-way valve, mid-position pressurised

Pneumatic port (width)	
D-1	Width 42 mm/ISO size 1
D-2	Width 52 mm/ISO size 2
D-3	Width 65 mm/ISO size 3
3/4-D-4	Width 76 mm/ISO size 4

Electrical connection, operating voltage	
	No pilot control
24 DC	Individual plug, square design, 3-pin socket with port pattern to EN 175301-803, type A, 24 V DC
M12	Individual plug, round design, M12x1, 2-pin to VDMA, 24 V DC
M12D	Individual plug, round design, M12x1, 4-pin to Desina, 24 V DC

Pilot air supply	
	Internal
S	External

Reset method 5/2-way valve	
	Pneumatic spring
FR	Mechanical spring

Generation	
	Width 76 mm/ISO size 4
C	C series

Standard valves to ISO 5599-1

Peripherals overview



Valve on individual sub-base

Solenoid valve with solenoid coil MSN1

Solenoid valve with central plug M12, 3-pin

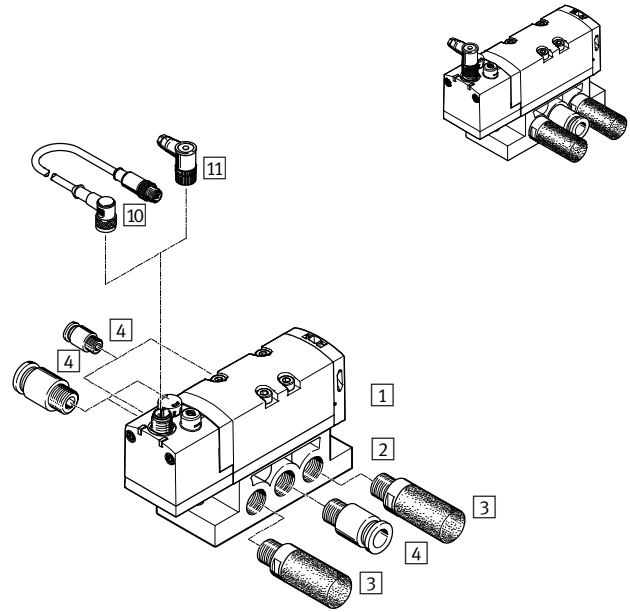
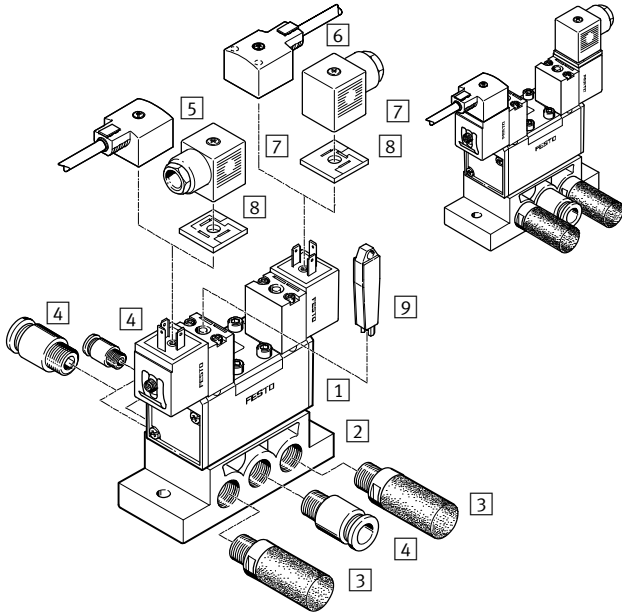

Individual components

	Type	Description	→ Page/Internet	
1	Solenoid valve	MN1H-...	Solenoid valve with solenoid coil, port pattern to ISO 5599-1, corresponding solenoid coils → page 121	20
	Solenoid valve	VSVA-...	Solenoid valve with central plug M12, 3-pin, port pattern to ISO 5599-1	44
2	Individual sub-base	NAS-...	Pneumatic ports, side	101
		NAU-...	Pneumatic ports, underneath	102
3	Silencer	U-...	For fitting in exhaust ports	silencer
4	Push-in fitting	QS-...	For connecting O.D. tubing	qs
5	Connecting cable	KMC-..., NEBV-...	Without LED	122
6	Connecting cable	KMC-..., NEBV-...	With LED	122
7	Plug socket	MSSD-...	For self-assembly	122
8	Illuminating seal	M...-LD	For indicating the signal status	122
9	Manual override	AHB-...	Tool for detenting manual override	123
10	Connecting cable	NEBU-...	-	123
11	Plug socket	SIE-...	For self-assembly	123

Valve variants

MN1H, JMN1H, MFH, JMFH

VSVA

MEBH, JMEBH

MDH, JMDH

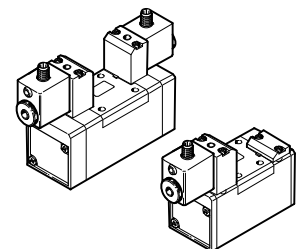
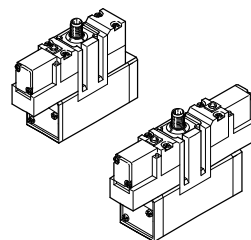
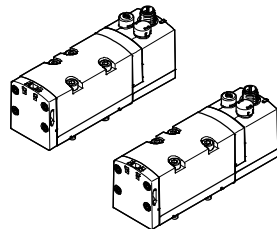
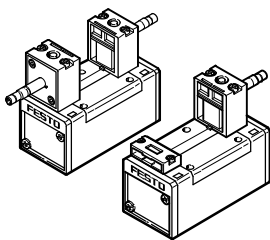

Standard valves to ISO 5599-1

Peripherals overview

FESTO

Accessories

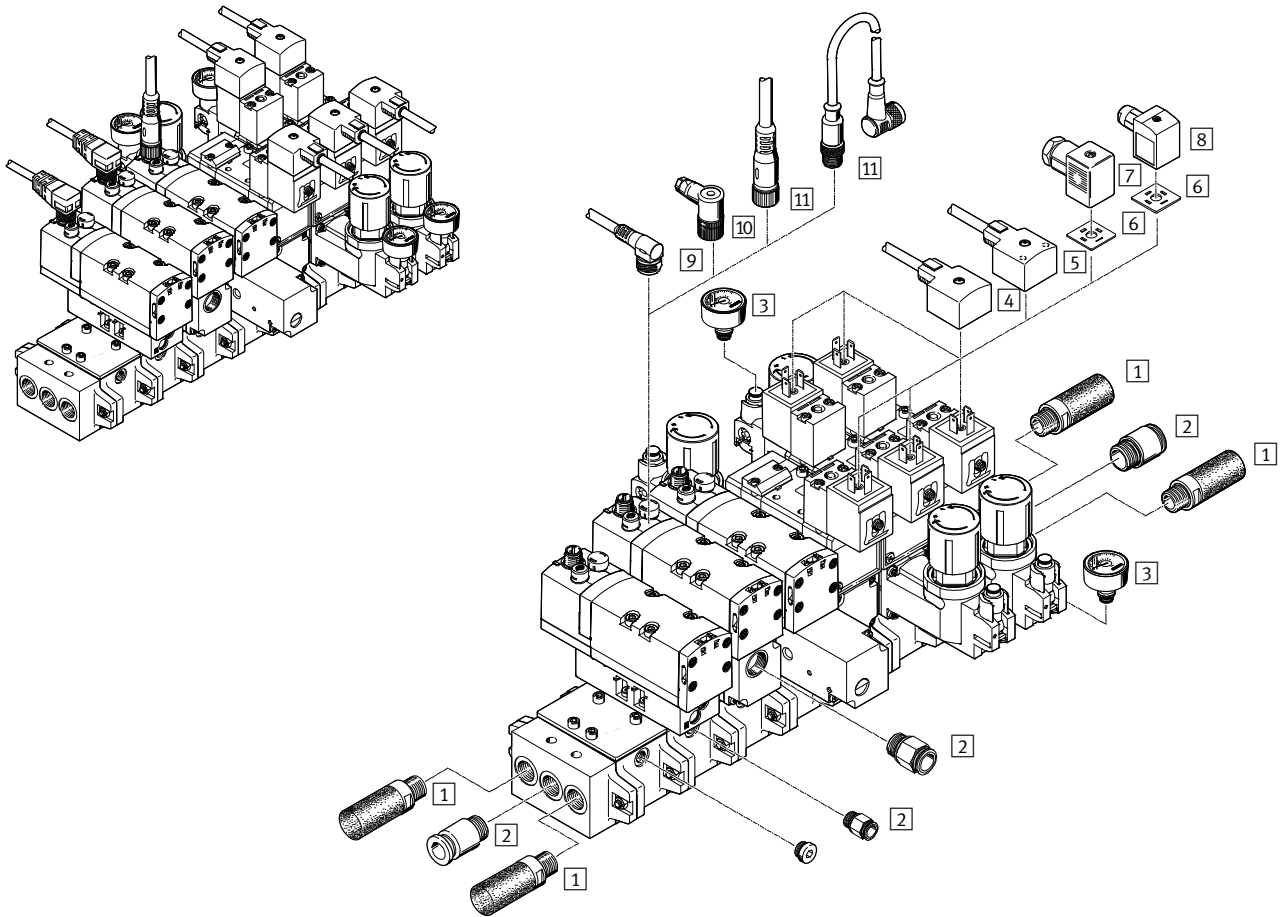

Individual components				
	Type	Description	→ Page/ Internet	
1	Silencer	U-...	For fitting in exhaust ports	silencer
2	Push-in fitting	QS-...	For connecting O.D. tubing	qs
3	Pressure gauge	PAGN-...	With push-in connector	123
4	Plug socket with cable	KMC-..., NEBV-...	Without LED	122
5	Plug socket with cable	KMC...LED, NEBV-...	With LED	122
6	Illuminating seal	M...-LD	For indicating the signal status	122
7	Socket	MSSD-C-M16	With screw terminal connection	122
8	Socket	MSSD-C-S-M16	With insulation displacement connection	122
9	Connecting cable	NEBU-...	Angled socket, M12x1, 5-pin	123
10	Socket	SIE-...	For self-assembly	123
11	Connecting cable	NEBU-...	Straight socket, M12x1, 5-pin	123

Standard valves to ISO 5599-1

System overview

FESTO

Manifold assembly

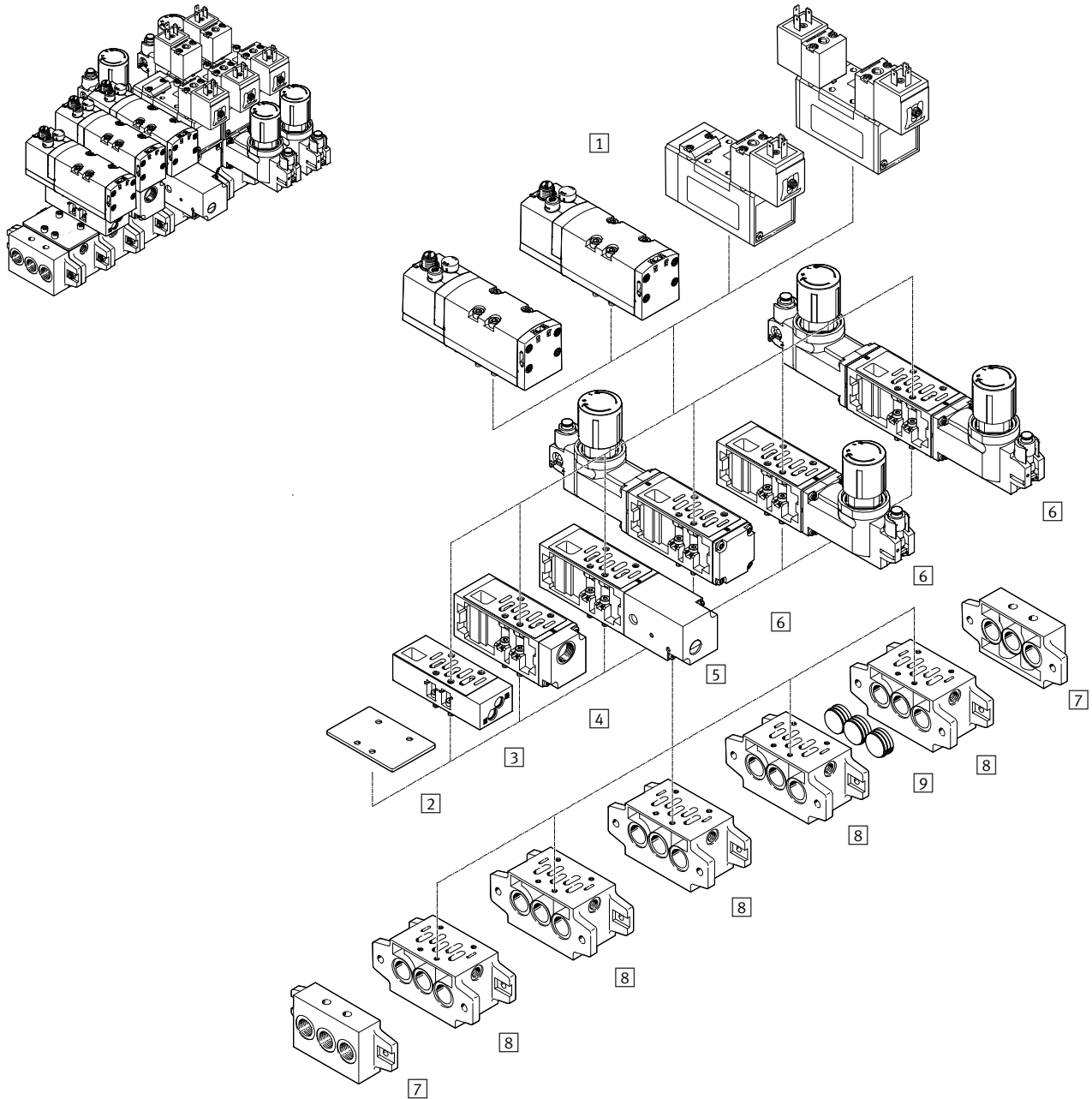

Standard valves to ISO 5599-1

System overview

Individual components				
	Type	Description	→ Page/ Internet	
1	Solenoid valve	MN1H-...	With armature for solenoid coil MSN1	20
		JMN1H-...	With armature for solenoid coil MSN1	20
		JMN1DH-...	With armature for solenoid coil MSN1	20
		MFH-...	With armature for solenoid coil MSF	32
		JMFH-...	With armature for solenoid coil MSF	32
		JMFDH-...	With armature for solenoid coil MSF	32
		VSPA-...	With central plug M12, 3-pin	44
		MEBH-...	With central plug M12, 4-pin	57
		JMEBH-...	With central plug M12, 4-pin	57
		JMEBDH-...	With central plug M12, 4-pin	57
		MDH-...	With solenoid coil MD with round plug M12x1	61
		JMDH-...	With solenoid coil MD with round plug M12x1	61
		JMDDH-...	With solenoid coil MD with round plug M12x1	61
		Pneumatic valve	VL-...	Port pattern to ISO 5599-1
J-...	Port pattern to ISO 5599-1		82	
JD-...	Port pattern to ISO 5599-1		82	
2	Blanking plate	NDV-...	For sealing unused manifold sub-bases	105
3	Flow control plate	VABF-S1-...-F1B1-C	Controls the flow of exhaust air in ducts 3 and 5	108
		GRO-ZP-...	Controls the flow of exhaust air in ducts 3 and 5	108
4	Vertical supply plate	VABF-S1-...-P1A3-G38	Alternative compressed air supply for port 1 of the assembled valve	111
5	Vertical pressure shut-off plate	VABF-S1-...-L1D1-C	For blocking duct 1 and duct 14 upstream of a valve	113
6	Regulator plate	VABF-S1-...-R...	Pressure regulator for manually setting a particular pressure in the regulated port upstream or downstream of the valve	115
		LR-ZP-...	Pressure regulator for manually setting a particular pressure in the regulated port upstream or downstream of the valve	115
7	End plate kit	NEV-...	With ports for air supply 1 and exhausts 3 and 5	104
8	Manifold sub-base	NAV-...	With ports 2 and 4 underneath	103
9	Isolating disc	NSC-...	For sealing ducts 1, 3, 5 between end plate and manifold sub-base, e.g. to create pressure zones	105

Standard valves to ISO 5599-1, solenoid coil MSN1

FESTO

Technical data – Width 42 mm

Flow rate
1200 l/min

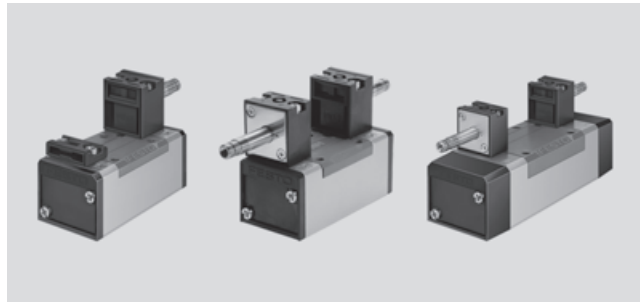

General technical data		
Design	Piston spool valve	
Sealing principle	Soft	
Actuation type	Electric	
Type of control	Piloted	
Direction of flow	With external pilot air supply	Reversible
	With internal pilot air supply	Non-reversible
Exhaust function	With flow control	
Manual override	Non-detenting, detenting via accessory	
Type of mounting	On sub-base, via through-hole	
Mounting position	Any	
Nominal size [mm]	8	
No overlap	Yes	
Width [mm]	42	
Grid dimension [mm]	43	
Pneumatic ports	Sub-base size 1 to ISO 5599-1	
Noise level [dB (A)]	85	
Conforms to standard	ISO 5599-1	
Certification With internal pilot air supply	c UL us Recognised (OL)	
Maritime classification ¹⁾	See certificate	

1) Additional information www.festo.com/sp → Certificates.

Flow rates			
Valve function	5/2-way single solenoid valve	5/2-way double solenoid valve	5/3-way valve
Standard nominal flow rate [l/min]	1200		

Switching times [ms]					
		Switching time on	Switching time off	Switching time changeover	Switching time changeover (dominant)
5/2-way single solenoid valve	MN1H-5/2-D-1-C	23	32	–	–
	MN1H-5/2-D-1-S-C	23	32	–	–
	MN1H-5/2-D-1-FR-C	17	39	–	–
	MN1H-5/2-D-1-FR-S-C	17	39	–	–
5/2-way double solenoid valve	JMN1H-5/2-D-1-C	–	–	18	–
	JMN1H-5/2-D-1-S-C	–	–	18	–
	JMN1DH-5/2-D-1-C	–	–	18	15
	JMN1DH-5/2-D-1-S-C	–	–	18	15
5/3-way valve	MN1H-5/3G-D-1-C	20	44	–	–
	MN1H-5/3G-D-1-S-C	20	44	–	–
	MN1H-5/3E-D-1-C	20	46	–	–
	MN1H-5/3E-D-1-S-C	20	46	–	–
	MN1H-5/3B-D-1-C	20	46	–	–
	MN1H-5/3B-D-1-S-C	20	46	–	–

Standard valves to ISO 5599-1, solenoid coil MSN1

Technical data – Width 42 mm

Operating and environmental conditions			
Reset method		Pneumatic spring	Mechanical spring
Operating medium		Compressed air to ISO 8573-1:2010 [7:4:4]	
Pilot medium		Compressed air to ISO 8573-1:2010 [7:4:4]	
Note on operating/pilot medium		Lubricated operation possible (in which case lubricated operation will always be required)	
Operating pressure	Internal pilot air supply	[bar] 2 ... 10	3 ... 10
	External pilot air supply	[bar] -0.9 ... +16	-0.9 ... +16
Pilot pressure		[bar] 2 ... 10	3 ... 10
Ambient temperature		[°C] -5 ... +50	
Temperature of medium		[°C] -5 ... +50	

Safety characteristics		
Max. positive test pulse with 0 signal	[µs]	3700
Max. negative test pulse with 1 signal	[µs]	4600
Shock resistance	Shock test with severity level 2 to FN 942017-5 and EN 60068-2-27	
Vibration resistance	Transport application test with severity level 1 to FN 942017-4 and EN 60068-2-6	

Electrical data	
Electrical connection	Via N1 coil, to be ordered separately
Degree of protection to EN 60529	IP65

Materials

Sectional view

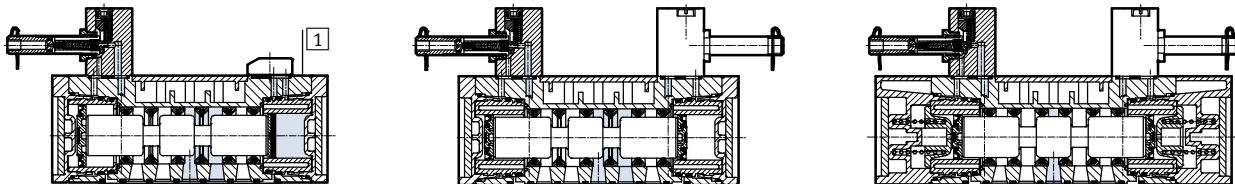

1	Housing	Die-cast aluminium
-	Seals	HNBR, NBR
-	Note on materials	RoHS-compliant

Standard valves to ISO 5599-1, solenoid coil MSN1

Technical data – Width 42 mm

Dimensions Download CAD data → www.festo.com
 5/2-way single solenoid valves

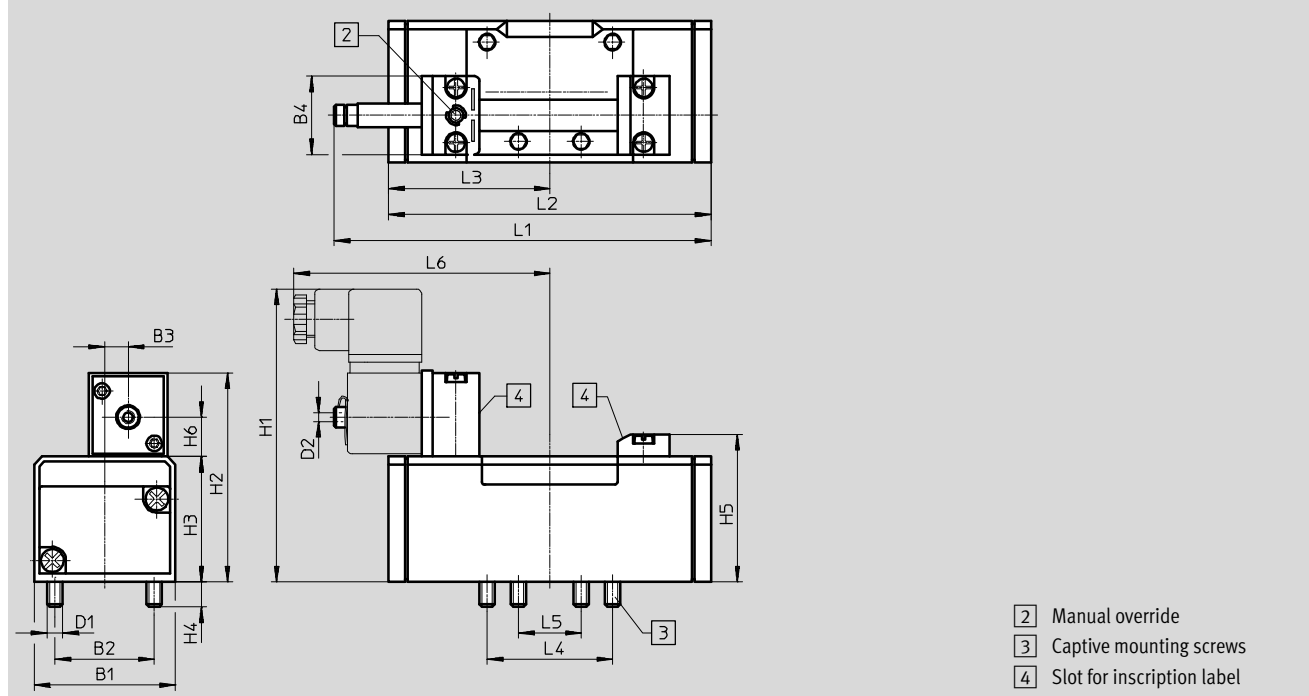

Type	B1	B2	B3	B4	D1	D2	H1	H2	H3	H4	H5	H6	L1	L2	L3	L4	L5	L6
MN1H-5/2- ...	42	28	6	30	M5	M5	106	74	38	9	46.5	15.3	117.5	87.6	43.8	36	18	89
MN1H-5/2- ... -FR- ...													128	98				

5/2-way double solenoid valves, 5/3-way valves

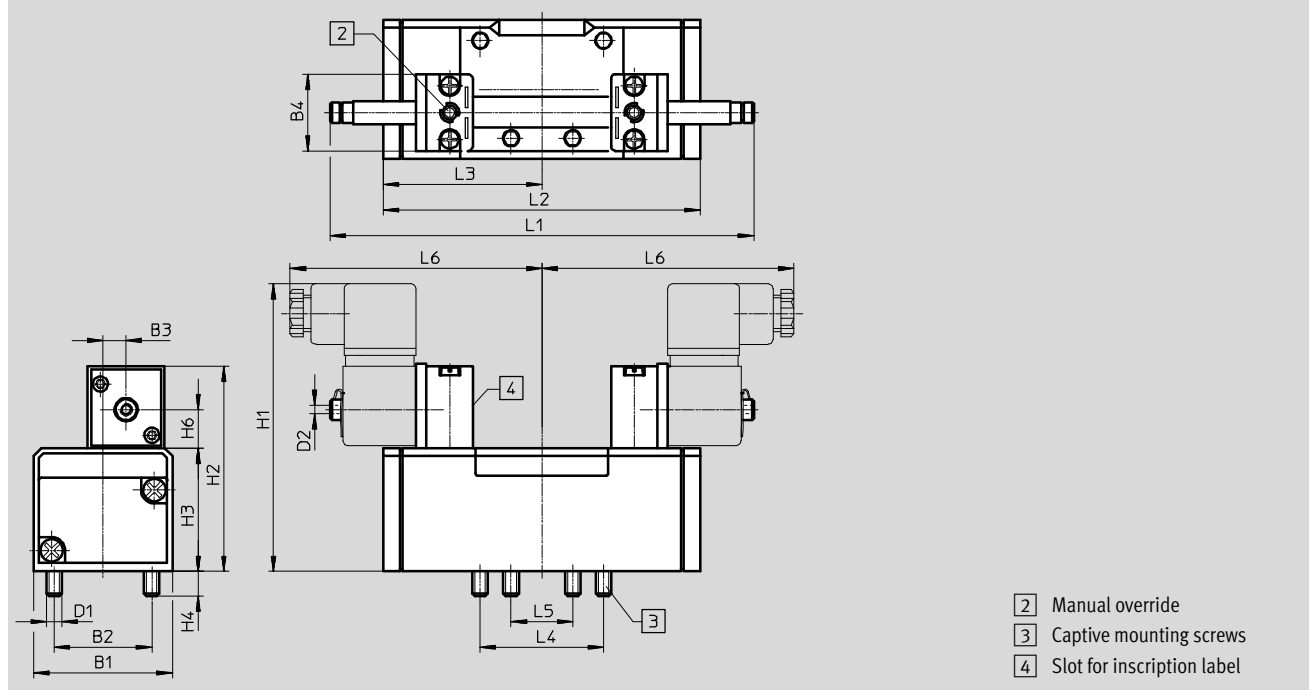

Type	B1	B2	B3	B4	D1	D2	H1	H2	H3	H4	H5	H6	L1	L2	L3	L4	L5	L6
JMN1H-5/2- ...	42	28	6	30	M5	M5	106	74	38	9	46.5	15.3	147.3	87.6	43.8	36	18	89
JMN1DH-5/2- ...														87.6				
MN1H-5/3...														108.4				

Standard valves to ISO 5599-1, solenoid coil MSN1

Ordering data – Width 42 mm

Ordering data – Valves with armature for solenoid coil MSN1 ¹⁾					
Circuit symbol	Description	Pilot air supply	Weight [g]	Part No.	Type
5/2-way single solenoid valve					
	Pneumatic spring reset method	Internal	450	159688	MN1H-5/2-D-1-C
	Pneumatic spring reset method	External	450	159686	MN1H-5/2-D-1-S-C
	Mechanical spring reset method	Internal	450	159687	MN1H-5/2-D-1-FR-C
	Mechanical spring reset method	External	450	159716	MN1H-5/2-D-1-FR-S-C
5/2-way double solenoid valve					
	–	Internal	610	159690	JMN1H-5/2-D-1-C
	–	External	610	159689	JMN1H-5/2-D-1-S-C
	With dominant signal at 14	Internal	610	159691	JMN1DH-5/2-D-1-C
	With dominant signal at 14	External	610	159717	JMN1DH-5/2-D-1-S-C
5/3-way valve					
	Normally closed, mechanical spring reset method	Internal	650	159681	MN1H-5/3G-D-1-C
	Normally closed, mechanical spring reset method	External	650	159680	MN1H-5/3G-D-1-S-C
	Normally exhausted, mechanical spring reset method	Internal	650	159683	MN1H-5/3E-D-1-C
	Normally exhausted, mechanical spring reset method	External	650	159682	MN1H-5/3E-D-1-S-C
	Normally open, mechanical spring reset method	Internal	650	159685	MN1H-5/3B-D-1-C
	Normally open, mechanical spring reset method	External	650	159684	MN1H-5/3B-D-1-S-C

1) Solenoid coils → Page 121

Standard valves to ISO 5599-1, solenoid coil MSN1

FESTO

Technical data – Width 52 mm

Flow rate
2300 l/min

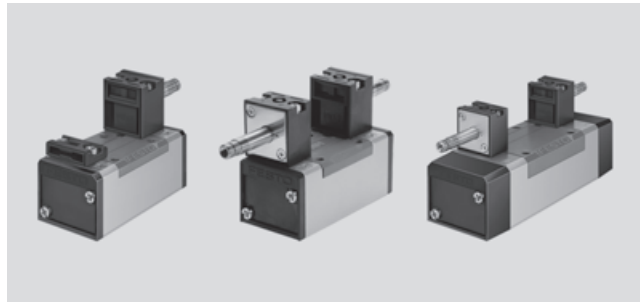

General technical data		
Design	Piston spool valve	
Sealing principle	Soft	
Actuation type	Electric	
Type of control	Piloted	
Direction of flow	With external pilot air supply	Reversible
	With internal pilot air supply	Non-reversible
Exhaust function	With flow control	
Manual override	Non-detenting, detenting via accessory	
Type of mounting	On sub-base, with through-hole and screw	
Mounting position	Any	
Nominal size	[mm] 11.5	
No overlap	Yes	
Width	[mm] 52	
Grid dimension	[mm] 56	
Pneumatic ports	Sub-base size 2 to ISO 5599-1	
Noise level	[dB (A)] 85	
Conforms to standard	ISO 5599-1	
Certification	With internal pilot air supply c UL us Recognised (OL)	
Maritime classification ¹⁾	See certificate	

1) Additional information www.festo.com/sp → Certificates.

Flow rates			
Valve function	5/2-way single solenoid valve	5/2-way double solenoid valve	5/3-way valve
Standard nominal flow rate	[l/min] 2300		

Switching times [ms]					
		Switching time on	Switching time off	Switching time changeover	Switching time changeover (dominant)
5/2-way single solenoid valve	MN1H-5/2-D-2-C	46	69	–	–
	MN1H-5/2-D-2-S-C	43	62	–	–
	MN1H-5/2-D-2-FR-C	24	62	–	–
	MN1H-5/2-D-2-FR-S-C	24	62	–	–
5/2-way double solenoid valve	JMN1H-5/2-D-2-C	–	–	21	–
	JMN1H-5/2-D-2-S-C	–	–	21	–
	JMN1DH-5/2-D-2-C	–	–	24	21
	JMN1DH-5/2-D-2-S-C	–	–	24	21
5/3-way valve	MN1H-5/3G-D-2-C	33	82	–	–
	MN1H-5/3G-D-2-S-C	33	82	–	–
	MN1H-5/3E-D-2-C	36	84	–	–
	MN1H-5/3E-D-2-S-C	36	84	–	–
	MN1H-5/3B-D-2-C	35	78	–	–
	MN1H-5/3B-D-2-S-C	35	78	–	–

Standard valves to ISO 5599-1, solenoid coil MSN1

Technical data – Width 52 mm

Operating and environmental conditions			
Reset method		Pneumatic spring	Mechanical spring
Operating medium		Compressed air to ISO 8573-1:2010 [7:4:4]	
Pilot medium		Compressed air to ISO 8573-1:2010 [7:4:4]	
Note on operating/pilot medium		Lubricated operation possible (in which case lubricated operation will always be required)	
Operating pressure	Internal pilot air supply	[bar] 2 ... 10	3 ... 10
	External pilot air supply	[bar] -0.9 ... +16	-0.9 ... +16
Pilot pressure		[bar] 2 ... 10	3 ... 10
Ambient temperature		[°C] -5 ... +50	
Temperature of medium		[°C] -5 ... +50	

Safety characteristics		
Max. positive test pulse with 0 signal	[µs]	3700
Max. negative test pulse with 1 signal	[µs]	4600
Shock resistance	Shock test with severity level 2 to FN 942017-5 and EN 60068-2-27	
Vibration resistance	Transport application test with severity level 1 to FN 942017-4 and EN 60068-2-6	

Electrical data	
Electrical connection	Via N1 coil, to be ordered separately
Degree of protection to EN 60529	IP65

Materials

Sectional view

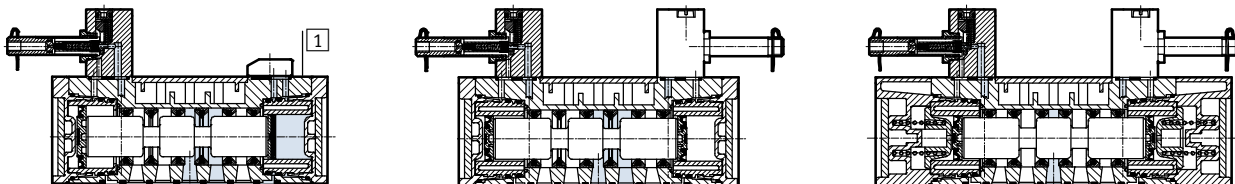

1	Housing	Die-cast aluminium
-	Seals	HNBR, NBR
-	Note on materials	RoHS-compliant

Standard valves to ISO 5599-1, solenoid coil MSN1

Technical data – Width 52 mm

Dimensions Download CAD data → www.festo.com
 5/2-way single solenoid valves

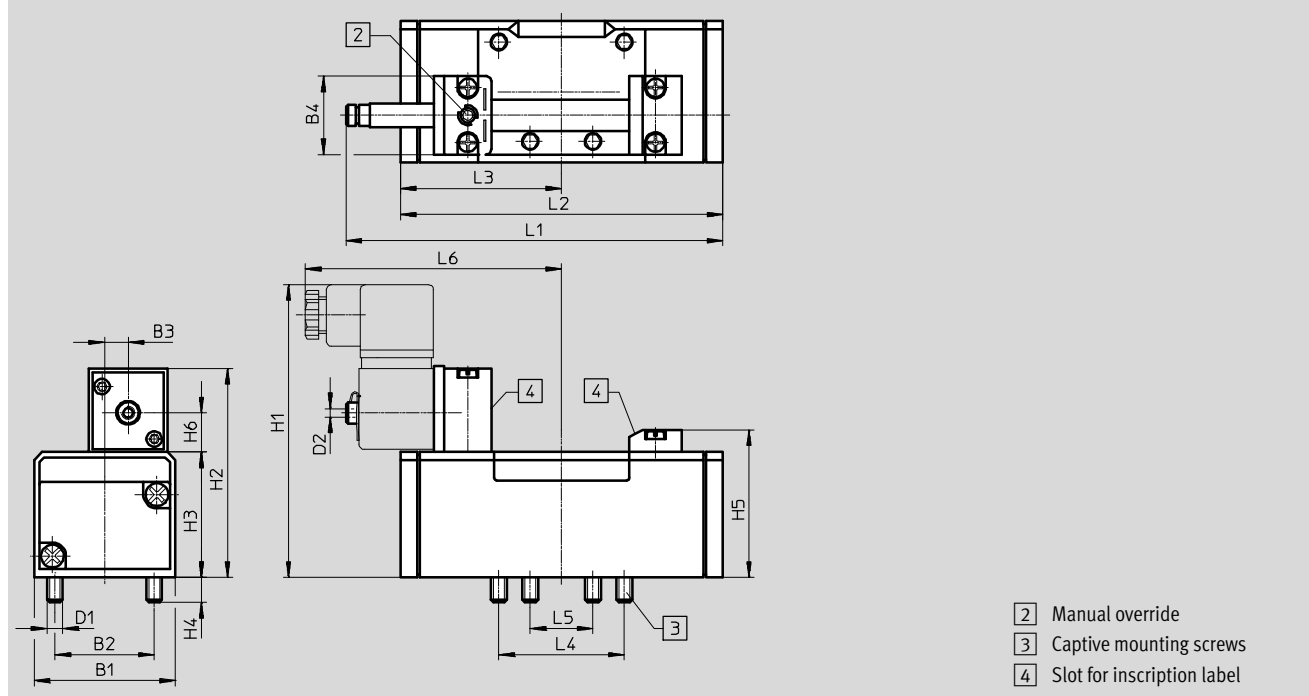

Type	B1	B2	B3	B4	D1	D2	H1	H2	H3	H4	H5	H6	L1	L2	L3	L4	L5	L6
MN1H-5/2- ...	54	38	9	30	M6	M5	116	84	48	9.5	56.5	15.3	147.6	123.4	61.7	48	24	98
MN1H-5/2- ... -FR- ...													161.5	140.7				

5/2-way double solenoid valves, 5/3-way valves

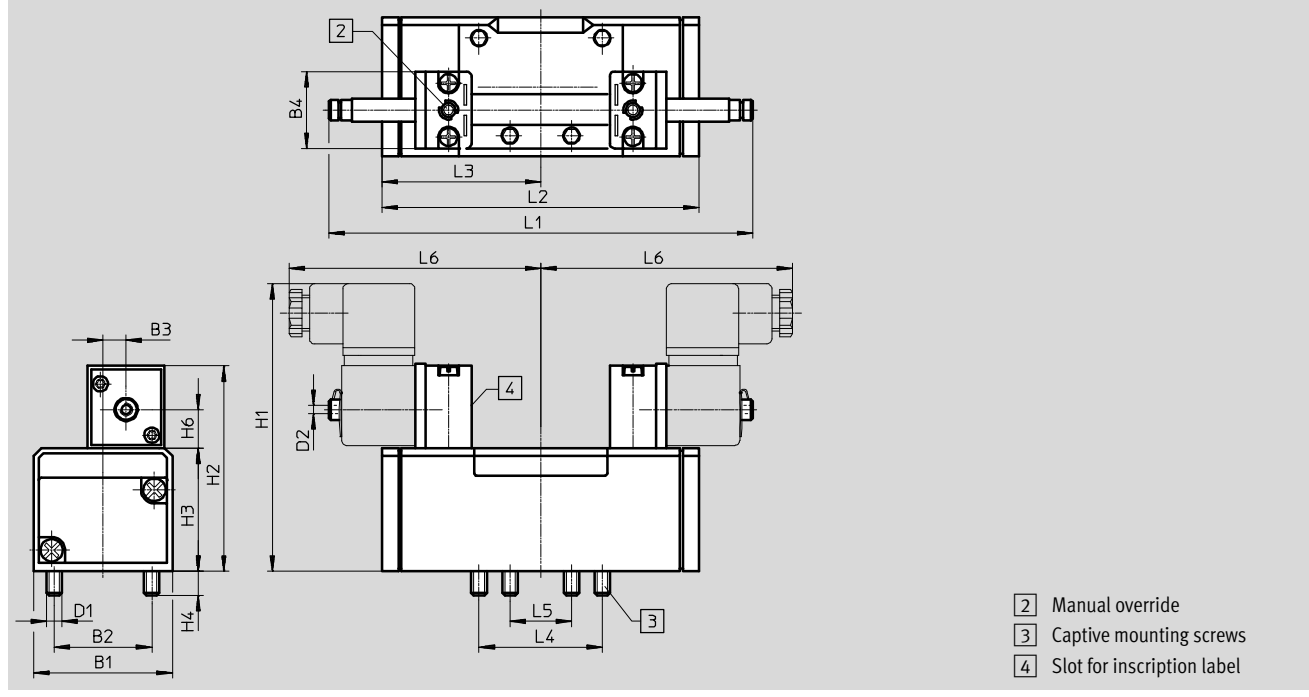

Type	B1	B2	B3	B4	D1	D2	H1	H2	H3	H4	H5	H6	L1	L2	L3	L4	L5	L6
JMN1H-5/2- ...	54	38	9	30	M6	M5	116	84	48	9.5	56.5	15.3	165	123.4	61.7	48	24	98
JMN1DH-5/2- ...														123.4	61.7			
MN1H-5/3...														158	79			

Standard valves to ISO 5599-1, solenoid coil MSN1

Ordering data – Width 52 mm

Ordering data – Valves with armature for solenoid coil MSN1 ¹⁾					
Circuit symbol	Description	Pilot air supply	Weight [g]	Part No.	Type
5/2-way single solenoid valve					
	Pneumatic spring reset method	Internal	710	159700	MN1H-5/2-D-2-C
	Pneumatic spring reset method	External	710	159698	MN1H-5/2-D-2-S-C
	Mechanical spring reset method	Internal	710	159699	MN1H-5/2-D-2-FR-C
	Mechanical spring reset method	External	710	159718	MN1H-5/2-D-2-FR-S-C
5/2-way double solenoid valve					
	–	Internal	940	159702	JMN1H-5/2-D-2-C
	–	External	940	159701	JMN1H-5/2-D-2-S-C
	With dominant signal at 14	Internal	940	159703	JMN1DH-5/2-D-2-C
	With dominant signal at 14	External	940	159719	JMN1DH-5/2-D-2-S-C
5/3-way valve					
	Normally closed, mechanical spring reset method	Internal	940	159693	MN1H-5/3G-D-2-C
	Normally closed, mechanical spring reset method	External	940	159692	MN1H-5/3G-D-2-S-C
	Normally exhausted, mechanical spring reset method	Internal	940	159695	MN1H-5/3E-D-2-C
	Normally exhausted, mechanical spring reset method	External	940	159694	MN1H-5/3E-D-2-S-C
	Normally open, mechanical spring reset method	Internal	940	159697	MN1H-5/3B-D-2-C
	Normally open, mechanical spring reset method	External	940	159696	MN1H-5/3B-D-2-S-C

1) Solenoid coils → Page 121

Standard valves to ISO 5599-1, solenoid coil MSN1

FESTO

Technical data – Width 65 mm

-  - Flow rate
Up to 4600 l/min

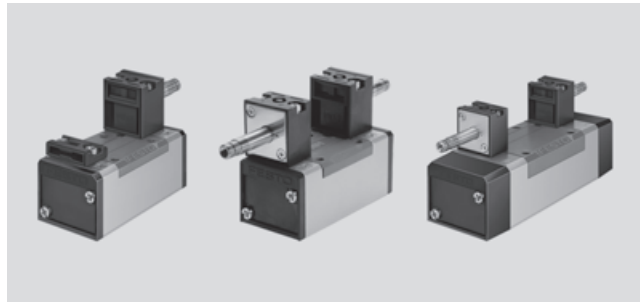

General technical data	
Design	Piston spool valve
Sealing principle	Soft
Actuation type	Electric
Type of control	Piloted
Direction of flow	With external pilot air supply Reversible With internal pilot air supply Non-reversible
Exhaust function	With flow control
Manual override	Non-detenting, detenting via accessory
Type of mounting	On sub-base, with through-hole and screw
Mounting position	Any
Nominal size [mm]	14.5
No overlap	Yes
Width [mm]	65
Grid dimension [mm]	71
Pneumatic ports	Sub-base size 3 to ISO 5599-1
Noise level [dB (A)]	85
Conforms to standard	ISO 5599-1
Certification With internal pilot air supply	c UL us Recognised (OL)
Maritime classification ¹⁾	See certificate

1) Additional information www.festo.com/sp → Certificates.

Flow rates				
Valve function		5/3-way valve		
		Normally closed	Normally exhausted	Normally open
Standard nominal flow rate [l/min]		4500	4100	4600
				4000

Standard valves to ISO 5599-1, solenoid coil MSN1

Technical data – Width 65 mm

Switching times [ms]		Switching time on	Switching time off	Switching time changeover	Switching time changeover (dominant)
5/2-way single solenoid valve	MN1H-5/2-D-3-C	49	71	–	–
	MN1H-5/2-D-3-S-C	49	71	–	–
	MN1H-5/2-D-3-FR-C	33	74	–	–
	MN1H-5/2-D-3-FR-S-C	33	74	–	–
5/2-way double solenoid valve	JMN1H-5/2-D-3-C	–	–	21	–
	JMN1H-5/2-D-3-S-C	–	–	21	–
	JMN1DH-5/2-D-3-C	–	–	24	21
	JMN1DH-5/2-D-3-S-C	–	–	24	21
5/3-way valve	MN1H-5/3G-D-3-C	33	82	–	–
	MN1H-5/3G-D-3-S-C	33	82	–	–
	MN1H-5/3E-D-3-C	36	84	–	–
	MN1H-5/3E-D-3-S-C	36	84	–	–
	MN1H-5/3B-D-3-C	35	78	–	–
	MN1H-5/3B-D-3-S-C	35	78	–	–

Operating and environmental conditions			Pneumatic spring	Mechanical spring
Reset method				
Operating medium			Compressed air to ISO 8573-1:2010 [7:4:4]	
Pilot medium			Compressed air to ISO 8573-1:2010 [7:4:4]	
Note on operating/pilot medium			Lubricated operation possible (in which case lubricated operation will always be required)	
Operating pressure	Internal pilot air supply	[bar]	2 ... 10	3 ... 10
	External pilot air supply	[bar]	–0.9 ... +16	–0.9 ... +16
Pilot pressure		[bar]	2 ... 10	3 ... 10
Ambient temperature		[°C]	–5 ... +50	
Temperature of medium		[°C]	–5 ... +50	

Safety characteristics		
Max. positive test pulse with 0 signal	[µs]	3700
Max. negative test pulse with 1 signal	[µs]	4600
Shock resistance		Shock test with severity level 2 to FN 942017-5 and EN 60068-2-27
Vibration resistance		Transport application test with severity level 1 to FN 942017-4 and EN 60068-2-6

Electrical data	
Electrical connection	Via N1 coil, to be ordered separately
Degree of protection to EN 60529	IP65

Materials

Sectional view

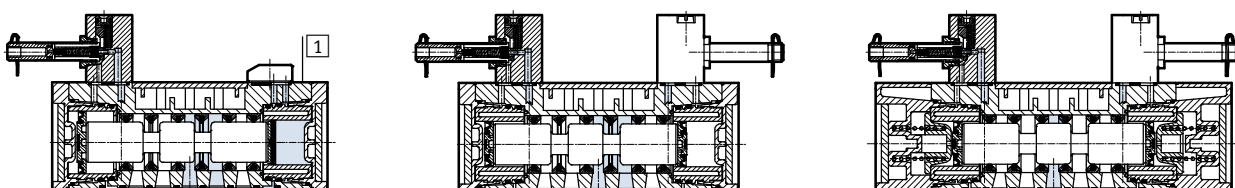

1	Housing	Die-cast aluminium
–	Seals	HNBR, NBR
–	Note on materials	RoHS-compliant

Standard valves to ISO 5599-1, solenoid coil MSN1

Technical data – Width 65 mm

Dimensions

Download CAD data → www.festo.com

5/2-way single solenoid valves

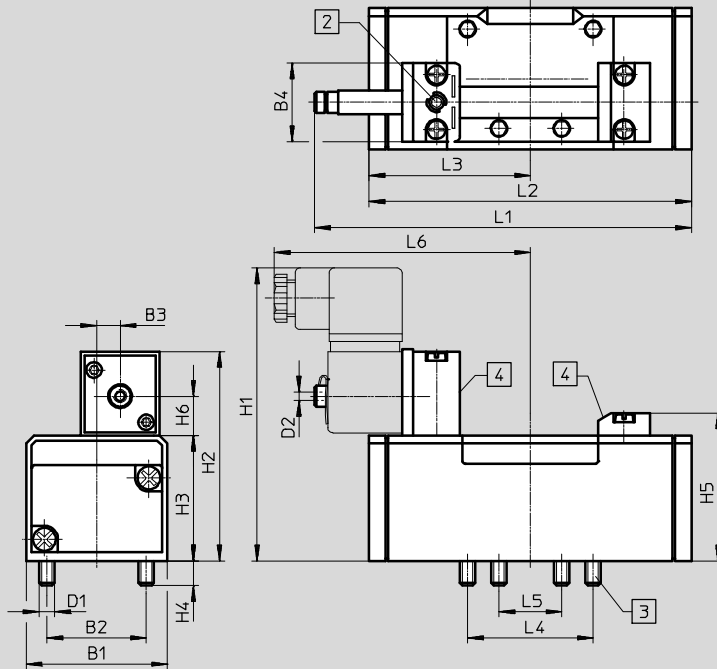

- 2 Manual override
- 3 Captive mounting screws
- 4 Slot for inscription label

Type	B1	B2	B3	B4	D1	D2	H1	H2	H3	H4	H5	H6	L1	L2	L3	L4	L5	L6
MN1H-5/2- ...	65	48	12	30	M8	M5	123	87.3	55	12	63.5	15.3	169	145.4	72.7	64	32	109
MN1H-5/2- ... -FR- ...													184.8	164.7				

5/2-way double solenoid valves, 5/3-way valves

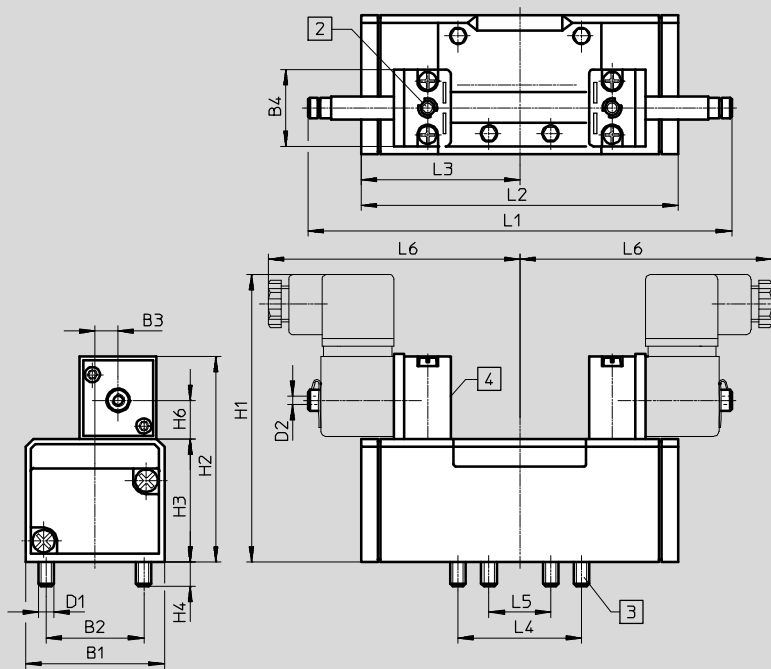

- 2 Manual override
- 3 Captive mounting screws
- 4 Slot for inscription label

Type	B1	B2	B3	B4	D1	D2	H1	H2	H3	H4	H5	H6	L1	L2	L3	L4	L5	L6
JMN1H-5/2- ...	65	48	12	30	M8	M5	123	87.3	55	12	-	15.3	185.7	145.4	72.7	64	32	109
JMN1DH-5/2- ...											-			145.4	72.7			
MN1H-5/3- ...											63.5			184	92			

Standard valves to ISO 5599-1, solenoid coil MSN1

Ordering data – Width 65 mm

Ordering data – Valves with armature for solenoid coil MSN1 ¹⁾					
Circuit symbol	Description	Pilot air supply	Weight [g]	Part No.	Type
5/2-way single solenoid valve					
	Pneumatic spring reset method	Internal	1000	159712	MN1H-5/2-D-3-C
	Pneumatic spring reset method	External	1000	159710	MN1H-5/2-D-3-S-C
	Mechanical spring reset method	Internal	1000	159711	MN1H-5/2-D-3-FR-C
	Mechanical spring reset method	External	1000	160896	MN1H-5/2-D-3-FR-S-C
5/2-way double solenoid valve					
	–	Internal	1090	159714	JMN1H-5/2-D-3-C
	–	External	1090	159713	JMN1H-5/2-D-3-S-C
	With dominant signal at 14	Internal	1090	159715	JMN1DH-5/2-D-3-C
	With dominant signal at 14	External	1090	160897	JMN1DH-5/2-D-3-S-C
5/3-way valve					
	Normally closed, mechanical spring reset method	Internal	1170	159705	MN1H-5/3G-D-3-C
	Normally closed, mechanical spring reset method	External	1170	159704	MN1H-5/3G-D-3-S-C
	Normally exhausted, mechanical spring reset method	Internal	1170	159707	MN1H-5/3E-D-3-C
	Normally exhausted, mechanical spring reset method	External	1170	159706	MN1H-5/3E-D-3-S-C
	Normally open, mechanical spring reset method	Internal	1170	159709	MN1H-5/3B-D-3-C
	Normally open, mechanical spring reset method	External	1170	159708	MN1H-5/3B-D-3-S-C

1) Solenoid coils → Page 121

Standard valves to ISO 5599-1, solenoid coil MSF

Technical data – Width 42 mm

Flow rate
1200 l/min

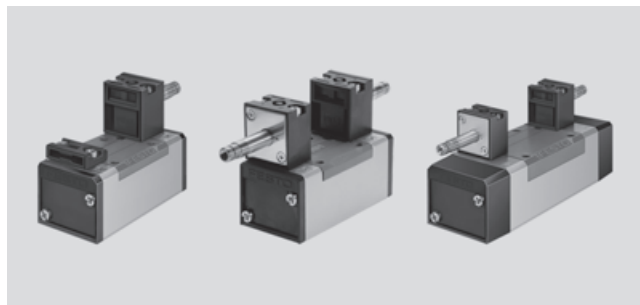

General technical data		
Type	MFH- ... -C, JMF- ... -C	MFH- ... -EX, JMF- ... -EX
Design	Piston spool valve	Piston spool valve
Sealing principle	Soft	Soft
Actuation type	Electric	Electric
Type of control	Piloted	Piloted
Direction of flow	With external pilot air supply	Reversible
	With internal pilot air supply	Non-reversible
Exhaust function	With flow control	With flow control
Manual override	Non-detenting, detenting via accessory	Non-detenting, detenting via accessory
Type of mounting	On sub-base, via through-hole	On sub-base, via through-hole
Mounting position	Any	Any
Nominal size [mm]	8	8
No overlap	Yes	Yes
Width [mm]	42	42
Grid dimension [mm]	43	43
Pneumatic ports	Sub-base size 1 to ISO 5599-1	Sub-base size 1 to ISO 5599-1
Noise level [dB (A)]	85	85
Conforms to standard	ISO 5599-1	ISO 5599-1
Maritime classification ¹⁾	See certificate	–

1) Additional information www.festo.com/sp → Certificates.

Flow rates			
Valve function	5/2-way single solenoid valve	5/2-way double solenoid valve	5/3-way valve
Standard nominal flow rate [l/min]	1200		

Switching times [ms]					
		Switching time on	Switching time off	Switching time changeover	Switching time changeover (dominant)
5/2-way single solenoid valve	MFH-5/2-...	23	35	–	–
	MFH-5/2-D-1-FR-...	16	45	–	–
5/2-way double solenoid valve	JMFH-...	–	–	16	–
	JMFDH-...	–	–	16	13
5/3-way valve	MFH-5/3G-D-1-C	18	35	–	–
	MFH-5/3G-D-1-C-EX	18	35	–	–
	MFH-5/3G-D-1-S-C	18	36	–	–
	MFH-5/3G-D-1-S-C-EX	18	36	–	–
	MFH-5/3E-D-1-C	18	36	–	–
	MFH-5/3E-D-1-C-EX	18	36	–	–
	MFH-5/3E-D-1-S-C	18	36	–	–
	MFH-5/3E-D-1-S-C-EX	18	36	–	–
	MFH-5/3B-D-1-C	18	36	–	–
	MFH-5/3B-D-1-C-EX	18	36	–	–
	MFH-5/3B-D-1-S-C	18	36	–	–
	MFH-5/3B-D-1-S-C-EX	18	36	–	–

Standard valves to ISO 5599-1, solenoid coil MSF

Technical data – Width 42 mm

ATEX	
Type	MFH- ... -EX, JMFH- ... -EX, JMFDH- ... -EX
ATEX category gas	II 2G
Ignition protection type for gas	c T4
ATEX category for dust	II 2D
Ignition protection type for dust	c T105°C
Explosion-proof ambient temperature [°C]	-5 ≤ Ta ≤ +40
CE marking (see declaration of conformity)	As per EU Explosion Protection Directive (ATEX)

Operating and environmental conditions			
Reset method		Pneumatic spring	Mechanical spring
Operating medium		Compressed air to ISO 8573-1:2010 [7:4:4]	
Pilot medium		Compressed air to ISO 8573-1:2010 [7:4:4]	
Note on operating/pilot medium		Lubricated operation possible (in which case lubricated operation will always be required)	
Operating pressure	Internal pilot air supply	[bar] 2 ... 10	3 ... 10
	External pilot air supply	[bar] -0.9 ... +16	-0.9 ... +16
Pilot pressure	[bar]	2 ... 10	3 ... 10
Ambient temperature	[°C]	-5 ... +40	
Temperature of medium	[°C]	-10 ... +60	
	[°C]	-5 ... +40 (MFH- ... -EX, JMFH- ... -EX, JMFDH- ... -EX)	

Safety characteristics		
Max. positive test pulse with 0 signal	[µs]	2200
Max. negative test pulse with 1 signal	[µs]	3700
Shock resistance	Shock test with severity level 2 to FN 942017-5 and EN 60068-2-27	
Vibration resistance	Transport application test with severity level 1 to FN 942017-4 and EN 60068-2-6	

Electrical data	
Electrical connection	Via F coil, to be ordered separately
Degree of protection to EN 60529	IP65

Materials

Sectional view

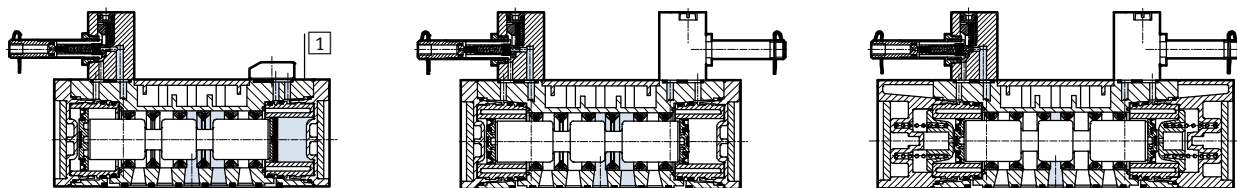

1	Housing	Die-cast aluminium
-	Seals	HNBR, NBR
-	Note on materials	RoHS-compliant

Standard valves to ISO 5599-1, solenoid coil MSF

Technical data – Width 42 mm

Dimensions

Download CAD data → www.festo.com

5/2-way single solenoid valves

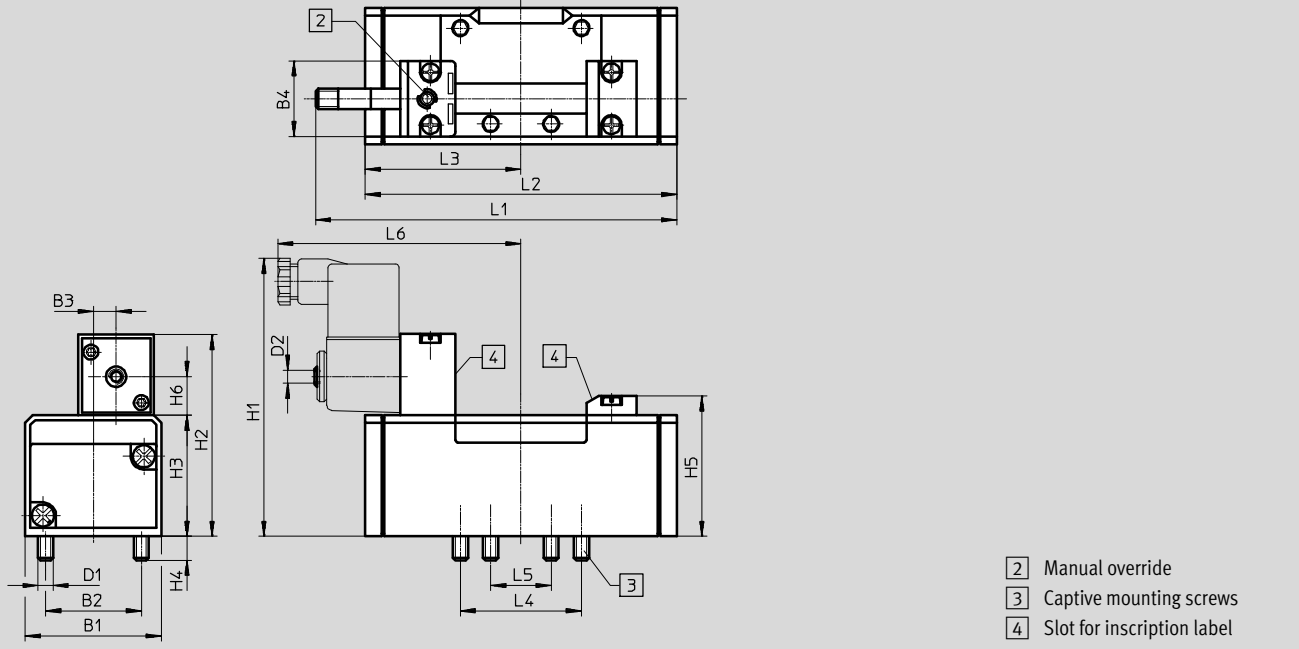

Type	B1	B2	B3	B4	D1	D2	H1	H2	H3	H4	H5	H6	L1	L2	L3	L4	L5	L6
MFH-5/2- ...	42	28	6	30	M5	M5	100	70.3	38	9	46.5	13.5	115	87.6	43.8	36	18	89
MFH-5/2- ... -FR- ...													125.6	98				

5/2-way double solenoid valves, 5/3-way valves

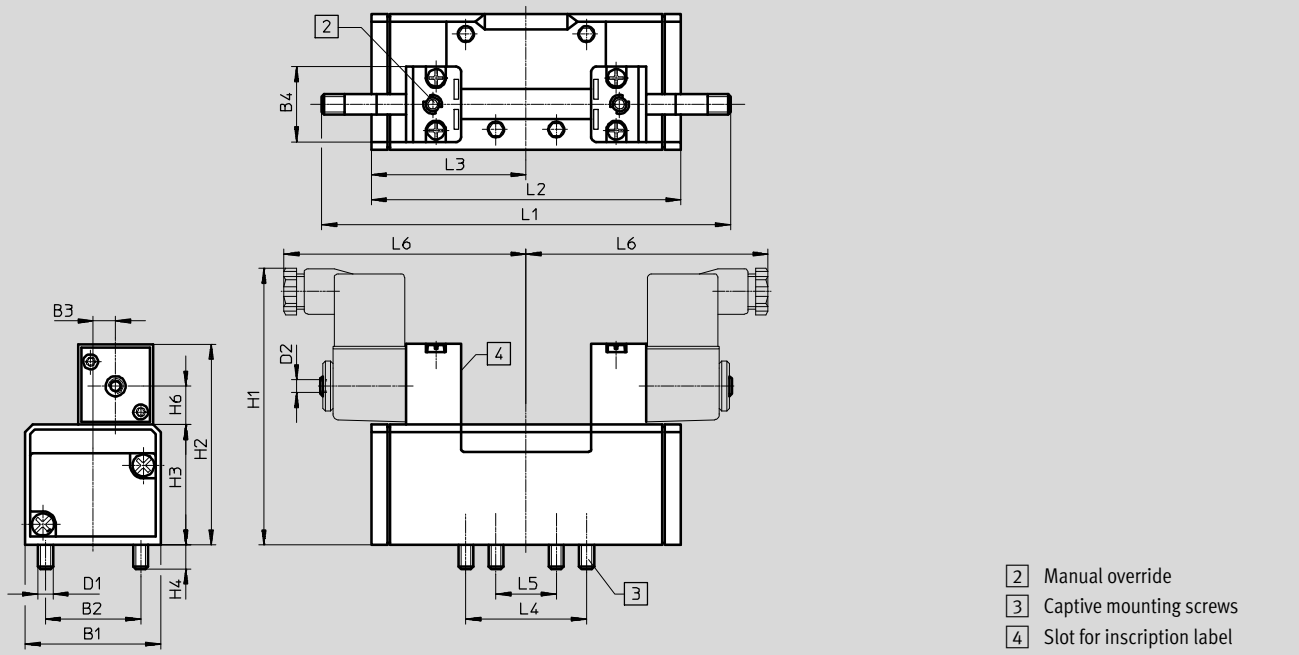

Type	B1	B2	B3	B4	D1	D2	H1	H2	H3	H4	H5	H6	L1	L2	L3	L4	L5	L6
JMFH-5/2- ...	42	28	6	30	M5	M5	100	70.3	38	9	-	13.5	142.6	87.6	43.8	36	18	89
JMFDH-5/2- ...														87.6	43.8			
MFH-5/3...														108.4	54.2			

Standard valves to ISO 5599-1, solenoid coil MSF

Ordering data – Width 42 mm

Ordering data – Valves with armature for solenoid coil MSF ¹⁾						
Circuit symbol	Description	Pilot air supply	Weight [g]		Part No.	Type
5/2-way single solenoid valve						
	Pneumatic spring reset method	Internal	390	–	150981	MFH-5/2-D-1-C
				ATEX category → page 33	535954	MFH-5/2-D-1-C-EX
	Pneumatic spring reset method	External	390	–	152562	MFH-5/2-D-1-S-C
				ATEX category → page 33	535957	MFH-5/2-D-1-S-C-EX
	Mechanical spring reset method	Internal	390	–	151016	MFH-5/2-D-1-FR-C
				ATEX category → page 33	535960	MFH-5/2-D-1-FR-C-EX
	Mechanical spring reset method	External	390	–	188510	MFH-5/2-D-1-FR-S-C
5/2-way double solenoid valve						
	–	Internal	490	–	150980	JMFH-5/2-D-1-C
				ATEX category → page 33	535963	JMFH-5/2-D-1-C-EX
	–	External	490	–	152563	JMFH-5/2-D-1-S-C
				ATEX category → page 33	535966	JMFH-5/2-D-1-S-C-EX
	With dominant signal at 14	Internal	490	–	151019	JMFDH-5/2-D-1-C
				ATEX category → page 33	536071	JMFDH-5/2-D-1-C-EX
5/3-way valve						
	Normally closed, mechanical spring reset method	Internal	520	–	150982	MFH-5/3G-D-1-C
				ATEX category → page 33	535969	MFH-5/3G-D-1-C-EX
	Normally closed, mechanical spring reset method	External	520	–	152564	MFH-5/3G-D-1-S-C
				ATEX category → page 33	535972	MFH-5/3G-D-1-S-C-EX
	Normally exhausted, mechanical spring reset method	Internal	520	–	150983	MFH-5/3E-D-1-C
				ATEX category → page 33	535975	MFH-5/3E-D-1-C-EX
	Normally exhausted, mechanical spring reset method	External	520	–	152565	MFH-5/3E-D-1-S-C
				ATEX category → page 33	535978	MFH-5/3E-D-1-S-C-EX
	Normally open, mechanical spring reset method	Internal	520	–	150984	MFH-5/3B-D-1-C
				ATEX category → page 33	535981	MFH-5/3B-D-1-C-EX
	Normally open, mechanical spring reset method	External	520	–	152566	MFH-5/3B-D-1-S-C
				ATEX category → page 33	535984	MFH-5/3B-D-1-S-C-EX

1) Solenoid coils → page 121

Standard valves to ISO 5599-1, solenoid coil MSF

FESTO

Technical data – Width 52 mm

Flow rate
2300 l/min

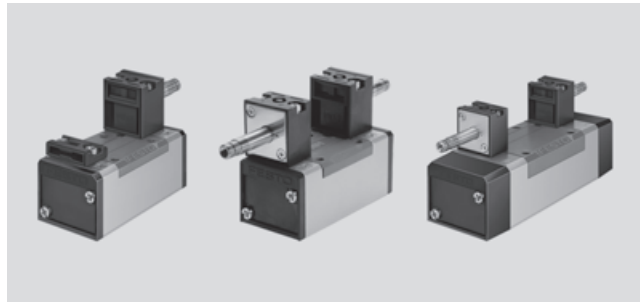

General technical data		
Type	MFH- ... -C, JMF- ... -C	MFH- ... -EX, JMF- ... -EX
Design	Piston spool valve	Piston spool valve
Sealing principle	Soft	Soft
Actuation type	Electric	Electric
Type of control	Piloted	Piloted
Direction of flow	With external pilot air supply	Reversible
	With internal pilot air supply	Non-reversible
Exhaust function	With flow control	With flow control
Manual override	Non-detenting, detenting via accessory	Non-detenting, detenting via accessory
Type of mounting	On sub-base, with through-hole and screw	On sub-base, with through-hole and screw
Mounting position	Any	Any
Nominal size [mm]	11.5	11.5
No overlap	Yes	Yes
Width [mm]	52	52
Grid dimension [mm]	56	56
Pneumatic ports	Sub-base size 2 to ISO 5599-1	Sub-base size 2 to ISO 5599-1
Noise level [dB (A)]	85	85
Conforms to standard	ISO 5599-1	ISO 5599-1
Maritime classification ¹⁾	See certificate	–

1) Additional information www.festo.com/sp → Certificates.

Flow rates			
Valve function	5/2-way single solenoid valve	5/2-way double solenoid valve	5/3-way valve
Standard nominal flow rate [l/min]	2300		

Switching times [ms]					
		Switching time on	Switching time off	Switching time changeover	Switching time changeover (dominant)
5/2-way single solenoid valve	MFH-5/2-...	48	71	–	–
	MFH-5/2-D-2-FR-...	27	73	–	–
5/2-way double solenoid valve	JMFH-...	–	–	18	–
	JMFDH-...	–	–	18	18
5/3-way valve	MFH-5/3G-...	33	63	–	–
	MFH-5/3E-...	35	67	–	–
	MFH-5/3B-...	35	69	–	–

ATEX	
Type	MFH- ... -EX, JMFH- ... -EX, JMFDH- ... -EX
ATEX category gas	II 2G
Ignition protection type for gas	c T4
ATEX category for dust	II 2D
Ignition protection type for dust	c T105°C
Explosion-proof ambient temperature [°C]	–5 ≤ Ta ≤ +40
CE marking (see declaration of conformity)	As per EU Explosion Protection Directive (ATEX)

Standard valves to ISO 5599-1, solenoid coil MSF

Technical data – Width 52 mm

Operating and environmental conditions			
Reset method		Pneumatic spring	
		Mechanical spring	
Operating medium		Compressed air to ISO 8573-1:2010 [7:4:4]	
Pilot medium		Compressed air to ISO 8573-1:2010 [7:4:4]	
Note on operating/pilot medium		Lubricated operation possible (in which case lubricated operation will always be required)	
Operating pressure	Internal pilot air supply	[bar]	2 ... 10
			3 ... 10
Operating pressure	External pilot air supply	[bar]	-0.9 ... +16
			-0.9 ... +16
Pilot pressure		[bar]	2 ... 10
			3 ... 10
Ambient temperature		[°C]	-5 ... +40
Temperature of medium		[°C]	-10 ... +60

Safety characteristics		
Max. positive test pulse with 0 signal	[µs]	2200
Max. negative test pulse with 1 signal	[µs]	3700
Shock resistance	Shock test with severity level 2 to FN 942017-5 and EN 60068-2-27	
Vibration resistance	Transport application test with severity level 1 to FN 942017-4 and EN 60068-2-6	

Electrical data	
Electrical connection	Via F coil, to be ordered separately
Degree of protection to EN 60529	IP65

Materials

Sectional view

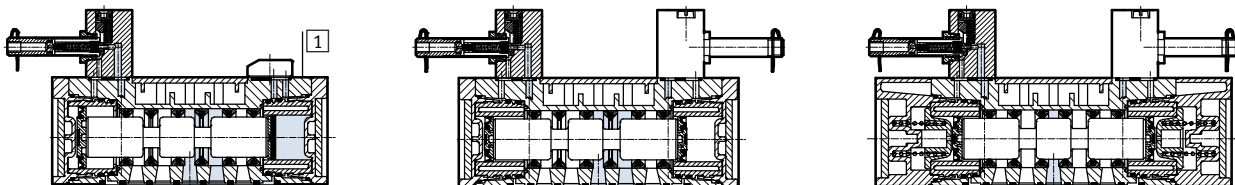

1	Housing	Die-cast aluminium
-	Seals	HNBR, NBR
-	Note on materials	RoHS-compliant

Standard valves to ISO 5599-1, solenoid coil MSF

Technical data – Width 52 mm

Dimensions

Download CAD data → www.festo.com

5/2-way single solenoid valves

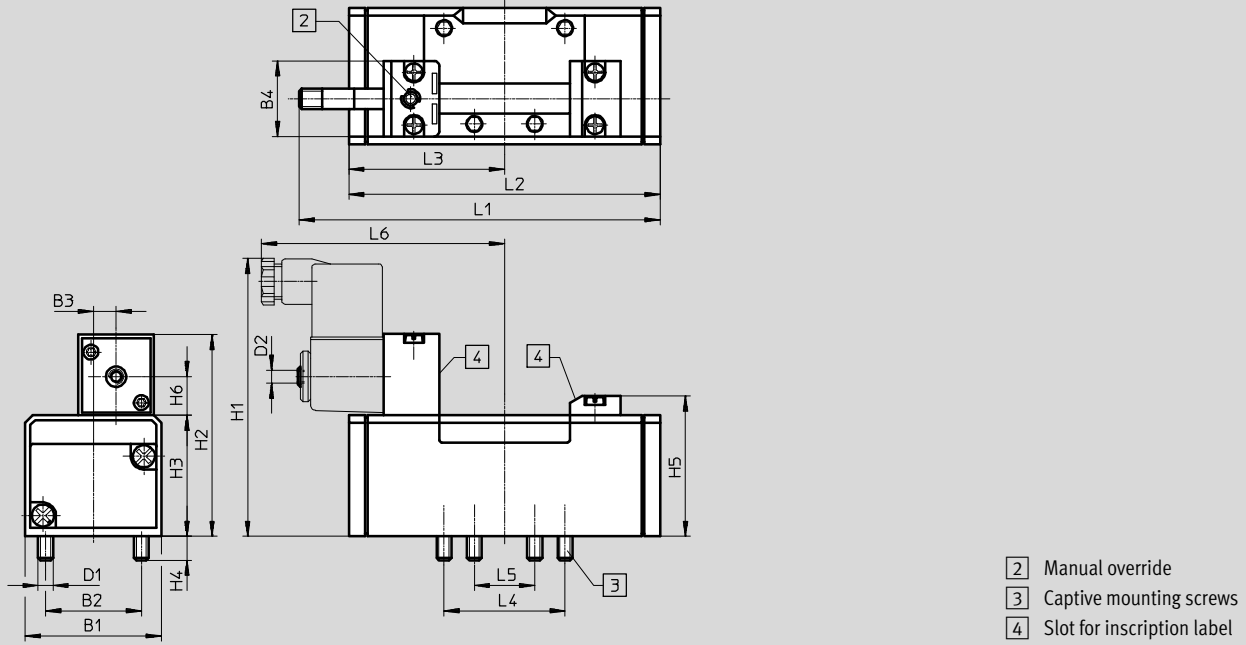

Type	B1	B2	B3	B4	D1	D2	H1	H2	H3	H4	H5	H6	L1	L2	L3	L4	L5	L6
MFH-5/2- ...	54	38	9	30	M6	M5	110	80.3	48	9.5	56.5	13.5	142	123.4	61.7	48	24	98
MFH-5/2- ... -FR- ...													159.4	140.7				

5/2-way double solenoid valves, 5/3-way valves

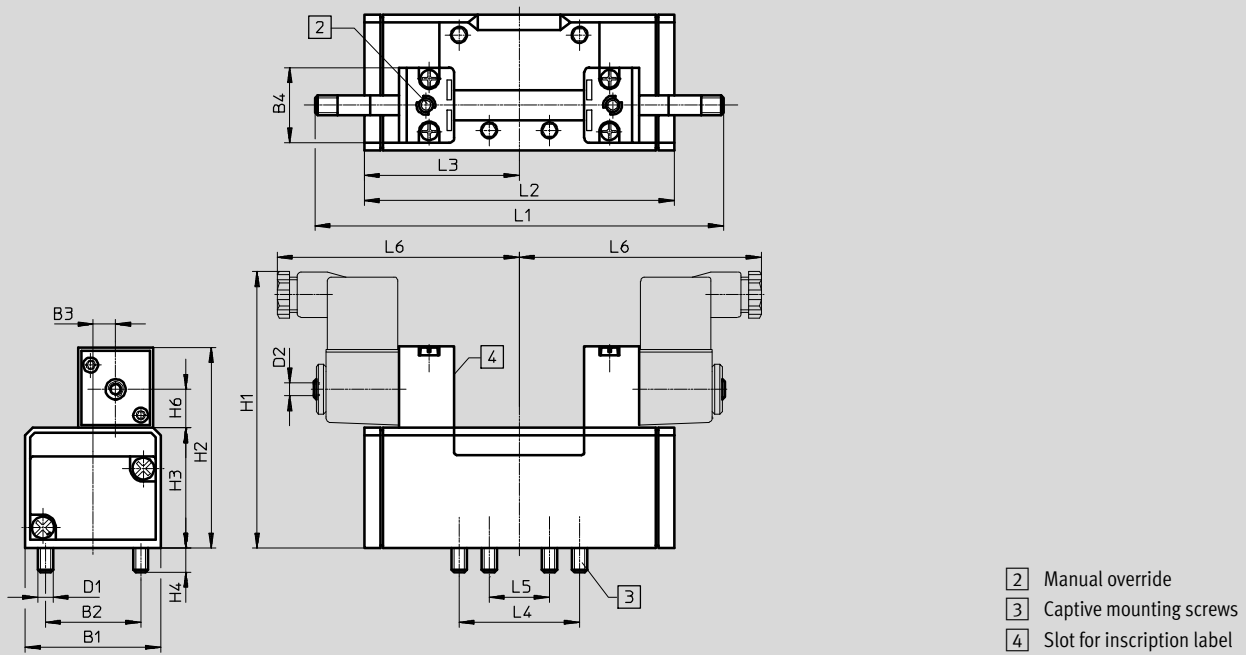

Type	B1	B2	B3	B4	D1	D2	H1	H2	H3	H4	H5	H6	L1	L2	L3	L4	L5	L6
JMFH-5/2- ...	54	38	9	30	M6	M5	110	80.3	48	9.5	-	13.5	160.4	123.4	61.7	48	24	97
JMFDH-5/2- ...													160.4	123.4	61.7			97
MFH-5/3...													160	158	79	98		

Standard valves to ISO 5599-1, solenoid coil MSF

Ordering data – Width 52 mm

Ordering data – Valves with armature for solenoid coil MSF ¹⁾						
Circuit symbol	Description	Pilot air supply	Weight [g]		Part No.	Type
5/2-way single solenoid valve						
	Pneumatic spring reset method	Internal	650	–	151851	MFH-5/2-D-2-C
				ATEX category → page 36	535955	MFH-5/2-D-2-C-EX
	Pneumatic spring reset method	External	650	–	151022	MFH-5/2-D-2-S-C
				ATEX category → page 36	535958	MFH-5/2-D-2-S-C-EX
	Mechanical spring reset method	Internal	650	–	151709	MFH-5/2-D-2-FR-C
				ATEX category → page 36	535961	MFH-5/2-D-2-FR-C-EX
5/2-way double solenoid valve						
	–	Internal	820	–	151852	JMFH-5/2-D-2-C
				ATEX category → page 36	535964	JMFH-5/2-D-2-C-EX
	–	External	820	–	151023	JMFH-5/2-D-2-S-C
				ATEX category → page 36	535967	JMFH-5/2-D-2-S-C-EX
	With dominant signal at 14	Internal	820	–	151853	JMFDH-5/2-D-2-C
				ATEX category → page 36	536072	JMFDH-5/2-D-2-C-EX
5/3-way valve						
	Normally closed, mechanical spring reset method	Internal	820	–	151854	MFH-5/3G-D-2-C
				ATEX category → page 36	535970	MFH-5/3G-D-2-C-EX
	Normally closed, mechanical spring reset method	External	820	–	151024	MFH-5/3G-D-2-S-C
				ATEX category → page 36	535973	MFH-5/3G-D-2-S-C-EX
	Normally exhausted, mechanical spring reset method	Internal	820	–	151855	MFH-5/3E-D-2-C
				ATEX category → page 36	535976	MFH-5/3E-D-2-C-EX
	Normally exhausted, mechanical spring reset method	External	820	–	151025	MFH-5/3E-D-2-S-C
				ATEX category → page 36	535979	MFH-5/3E-D-2-S-C-EX
	Normally open, mechanical spring reset method	Internal	820	–	151856	MFH-5/3B-D-2-C
				ATEX category → page 36	535982	MFH-5/3B-D-2-C-EX
	Normally open, mechanical spring reset method	External	820	–	151026	MFH-5/3B-D-2-S-C
				ATEX category → page 36	535985	MFH-5/3B-D-2-S-C-EX

1) Solenoid coils → page 121

Standard valves to ISO 5599-1, solenoid coil MSF

Technical data – Width 65 mm

 Flow rate
Up to 4600 l/min

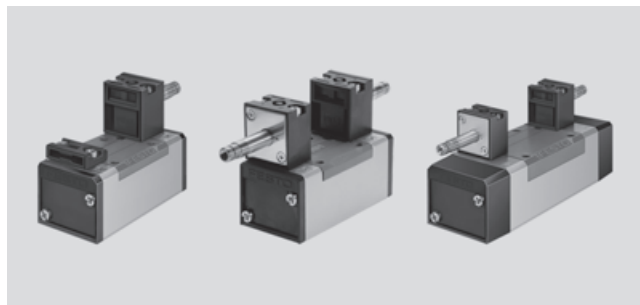

General technical data		
Type	MFH- ... -C, JMF- ... -C	MFH- ... -EX, JMF- ... -EX
Design	Piston spool valve	Piston spool valve
Sealing principle	Soft	Soft
Actuation type	Electric	Electric
Type of control	Piloted	Piloted
Direction of flow	With external pilot air supply	Reversible
	With internal pilot air supply	Non-reversible
Exhaust function	With flow control	With flow control
Manual override	Non-detenting, detenting via accessory	Non-detenting, detenting via accessory
Type of mounting	On sub-base, with through-hole and screw	On sub-base, with through-hole and screw
Mounting position	Any	Any
Nominal size	[mm] 14.5	14.5
No overlap	Yes	Yes
Width	[mm] 65	65
Grid dimension	[mm] 71	71
Pneumatic ports	Sub-base size 3 to ISO 5599-1	Sub-base size 3 to ISO 5599-1
Noise level	[dB (A)] 85	85
Conforms to standard	ISO 5599-1	ISO 5599-1
Maritime classification ¹⁾	See certificate	–

1) Additional information www.festo.com/sp → Certificates.

Flow rates				
Valve function	5/2-way valve	5/3-way valve		
		Normally closed	Normally exhausted	Normally open
Nominal flow rate	[l/min] 4500	4100	4600	4000

Switching times [ms]					
		Switching time on	Switching time off	Switching time changeover	Switching time changeover (dominant)
5/2-way single solenoid valve	MFH-5/2-...	60	66	–	–
	MFH-5/2-D-1-FR-...	28	79	–	–
5/2-way double solenoid valve	JMFH-...	–	–	18	–
	JMFDH-...	–	–	18	18
5/3-way valve	MFH-5/3G-...	36	77	–	–
	MFH-5/3E-...	37	78	–	–
	MFH-5/3B-...	36	75	–	–

Standard valves to ISO 5599-1, solenoid coil MSF

Technical data – Width 65 mm

ATEX	
Type	MFH- ... -EX, JMFH- ... -EX, JMFDH- ... -EX
ATEX category gas	II 2G
Ignition protection type for gas	c T4
ATEX category for dust	II 2D
Ignition protection type for dust	c T105°C
Explosion-proof ambient temperature [°C]	-5 ≤ Ta ≤ +40
CE marking (see declaration of conformity)	As per EU Explosion Protection Directive (ATEX)

Operating and environmental conditions			
Reset method		Pneumatic spring	Mechanical spring
Operating medium		Compressed air to ISO 8573-1:2010 [7:4:4]	
Pilot medium		Compressed air to ISO 8573-1:2010 [7:4:4]	
Note on operating/pilot medium		Lubricated operation possible (in which case lubricated operation will always be required)	
Operating pressure	Internal pilot air supply	[bar] 2 ... 10	3 ... 10
	External pilot air supply	[bar] -0.9 ... +16	-0.9 ... +16
Pilot pressure	[bar]	2 ... 10	3 ... 10
Ambient temperature	[°C]	-5 ... +40	
Temperature of medium	[°C]	-10 ... +60	

Safety characteristics		
Max. positive test pulse with 0 signal	[μs]	2200
Max. negative test pulse with 1 signal	[μs]	3700
Shock resistance	Shock test with severity level 2 to FN 942017-5 and EN 60068-2-27	
Vibration resistance	Transport application test with severity level 1 to FN 942017-4 and EN 60068-2-6	

Electrical data	
Electrical connection	Via F coil, to be ordered separately
Degree of protection to EN 60529	IP65

Materials

Sectional view

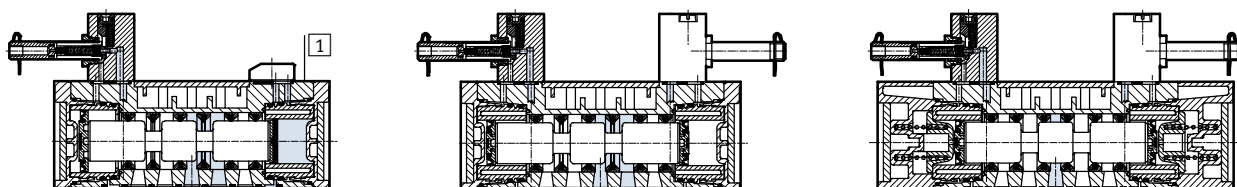

1	Housing	Die-cast aluminium
-	Seals	HNBR, NBR
-	Note on materials	RoHS-compliant

Standard valves to ISO 5599-1, solenoid coil MSF

Technical data – Width 65 mm

Dimensions

Download CAD data → www.festo.com

5/2-way single solenoid valves

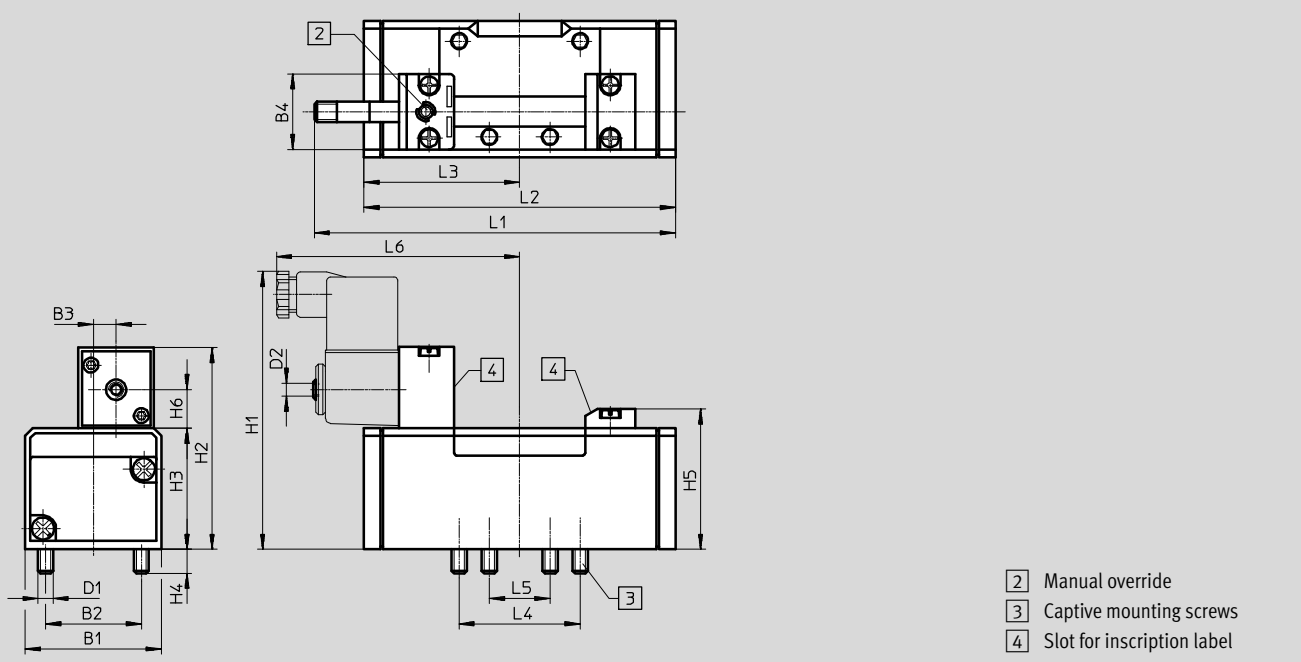

Type	B1	B2	B3	B4	D1	D2	H1	H2	H3	H4	H5	H6	L1	L2	L3	L4	L5	L6
MFH-5/2- ...	65	48	12	30	M8	M5	117	87.3	55	12	63.5	13.5	163	145.4	72.7	64	32	109
MFH-5/2- ... -FR- ...													182	164.7				

5/2-way double solenoid valves, 5/3-way valves

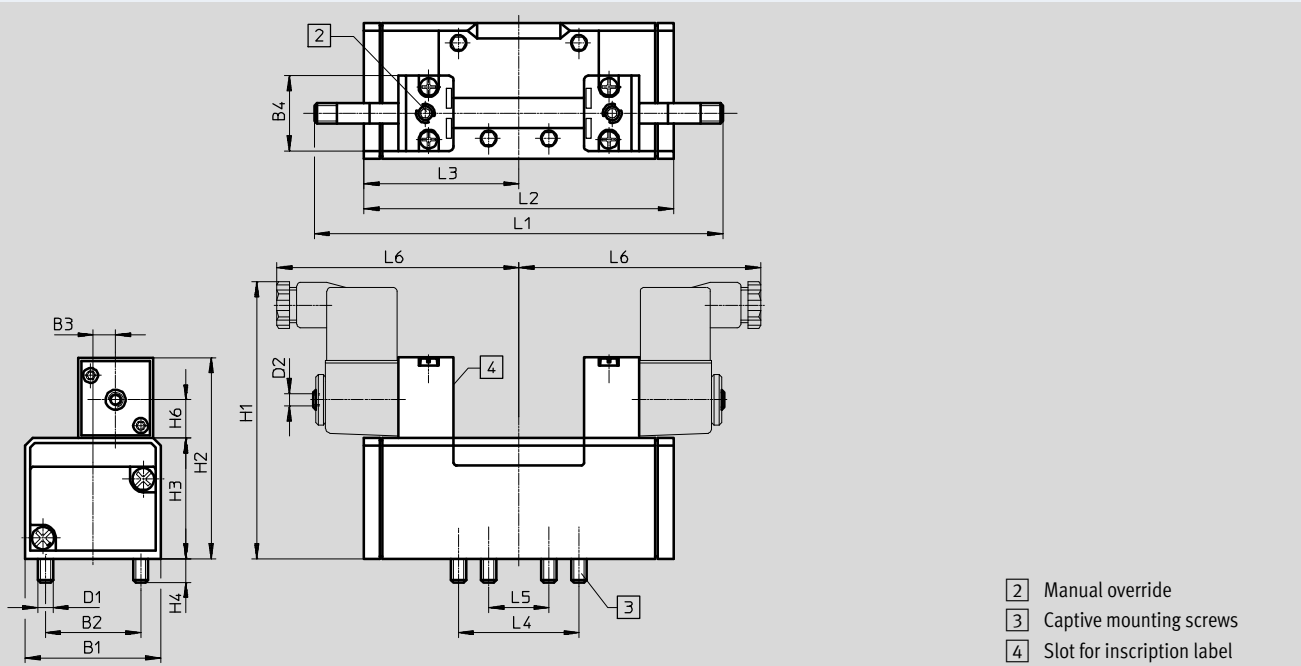

Type	B1	B2	B3	B4	D1	D2	H1	H2	H3	H4	H5	H6	L1	L2	L3	L4	L5	L6
JMFH-5/2- ...	65	48	12	30	M8	M5	117	87.3	55	12	-	13.5	181	145.4	72.7	64	32	109
JMFDH-5/2- ...														145.4	72.7			
MFH-5/3...														184	92			

Standard valves to ISO 5599-1, solenoid coil MSF

Ordering data – Width 65 mm

Ordering data – Valves with armature for solenoid coil MSF ¹⁾						
Circuit symbol	Description	Pilot air supply	Weight [g]		Part No.	Type
5/2-way single solenoid valve						
	Pneumatic spring reset method	Internal	960	–	151870	MFH-5/2-D-3-C
				ATEX category ➔ page 41	535956	MFH-5/2-D-3-C-EX
	Pneumatic spring reset method	External	960	–	151032	MFH-5/2-D-3-S-C
				ATEX category ➔ page 41	535959	MFH-5/2-D-3-S-C-EX
	Mechanical spring reset method	Internal	960	–	151711	MFH-5/2-D-3-FR-C
				ATEX category ➔ page 41	535962	MFH-5/2-D-3-FR-C-EX
5/2-way double solenoid valve						
	–	Internal	1060	–	151871	JMFH-5/2-D-3-C
				ATEX category ➔ page 41	535965	JMFH-5/2-D-3-C-EX
	–	External	1060	–	151033	JMFH-5/2-D-3-S-C
				ATEX category ➔ page 41	535968	JMFH-5/2-D-3-S-C-EX
	With dominant signal at 14	Internal	1060	–	151872	JMFDH-5/2-D-3-C
				ATEX category ➔ page 41	536073	JMFDH-5/2-D-3-C-EX
5/3-way valve						
	Normally closed, mechanical spring reset method	Internal	1040	–	151873	MFH-5/3G-D-3-C
				ATEX category ➔ page 41	535971	MFH-5/3G-D-3-C-EX
	Normally closed, mechanical spring reset method	External	1040	–	151034	MFH-5/3G-D-3-S-C
				ATEX category ➔ page 41	535974	MFH-5/3G-D-3-S-C-EX
	Normally exhausted, mechanical spring reset method	Internal	1040	–	151874	MFH-5/3E-D-3-C
				ATEX category ➔ page 41	535977	MFH-5/3E-D-3-C-EX
	Normally exhausted, mechanical spring reset method	External	1040	–	151035	MFH-5/3E-D-3-S-C
				ATEX category ➔ page 41	535980	MFH-5/3E-D-3-S-C-EX
	Normally open, mechanical spring reset method	Internal	1040	–	151875	MFH-5/3B-D-3-C
				ATEX category ➔ page 41	535983	MFH-5/3B-D-3-C-EX
	Normally open, mechanical spring reset method	External	1040	–	151036	MFH-5/3B-D-3-S-C
				ATEX category ➔ page 41	535986	MFH-5/3B-D-3-S-C-EX

1) Solenoid coils ➔ page 121

Standard valves to ISO 5599-1, central plug M12, 3-pin

Technical data – Width 42 mm

-  - Flow rate
Up to 1300 l/min

-  - Voltage
24 V DC

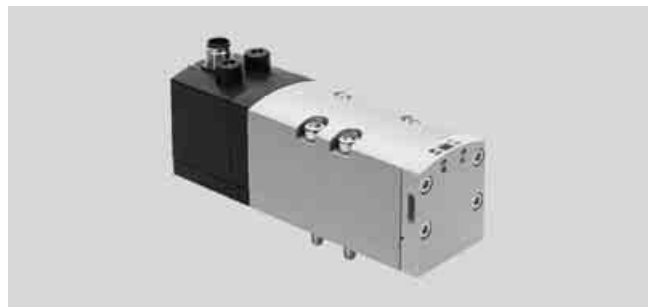

General technical data	
Design	Piston spool valve
Sealing principle	Soft
Actuation type	Electric
Type of control	Piloted
Exhaust function	Flow control, external or via vertically stacked flow control plate
Manual override	Non-detenting, detenting
Type of mounting	On sub-base
Mounting position	Any
Nominal size [mm]	11
No overlap	Yes
Width [mm]	42
Grid dimension [mm]	43
Pneumatic ports	Sub-base size 1 to ISO 5599-1
Conforms to standard	ISO 5599-1
Certification	c CSA us (OL)
	c UL us - Recognised (OL)

Flow rates				
Valve function	2/2-way valve	3/2-way valve	5/2-way valve	5/3-way valve
Standard nominal flow rate [l/min]	1300	1100	1300	1300
Valve	1600	1600	2000	1900
Valve on individual sub-base	1400	1200	1400	1400
Valve pneumatically interlinked	1300	1100	1300	1400

Switching times [ms]					
		Switching time on	Switching time off	Switching time changeover	Switching time changeover (dominant)
2x 2/2-way valve	VSVA-B-T22...	20	38	–	–
2x 3/2-way valve	VSVA-B-T32...	20	38	–	–
2x 3/2-way valve, reversible	VSVA-B-T32...	34	28	–	–
5/2-way single solenoid valve	VSVA-B-M52-A...	27	45	–	–
	VSVA-B-M52-M...	22	60	–	–
5/2-way double solenoid valve	VSVA-B-B52...	–	–	16	–
	VSVA-B-D52...	–	–	–	19
5/3-way valve	VSVA-B-P53...	22	65	–	–

Standard valves to ISO 5599-1, central plug M12, 3-pin

FESTO

Technical data – Width 42 mm

Operating and environmental conditions							
Valve function		2x 2/2-way valve	2x 3/2-way valve	2x 3/2-way valve, reversible	5/2-way valve	5/3-way valve	
Operating medium		Compressed air to ISO 8573-1:2010 [7:4:4]					
Pilot medium		Compressed air to ISO 8573-1:2010 [7:4:4]					
Note on operating/pilot medium		Lubricated operation (in which case lubricated operation will always be required)					
Operating pressure	Internal pilot air supply	[bar]	3 ... 10	3 ... 10	–	3 ... 10	3 ... 10
	External pilot air supply	[bar]	3 ... 10	3 ... 10	–0.9 ... +10	–0.9 ... +16	–0.9 ... +16
Pilot pressure		[bar]	3 ... 10				
Ambient temperature		[°C]	–5 ... +50				
Relative humidity		[%]	0 ... 90				

Safety characteristics						
Valve function		2x 3/2-way valve	5/2-way valve	5/2-way valve, with dominant signal at 14	5/3-way valve	
Max. positive test pulse with 0 signal		[µs]	1600	1400	1600	1400
Max. negative test pulse with 1 signal		[µs]	1100	900	1100	900
Shock resistance		Shock test with severity level 2 to FN 942017-5 and EN 60068-2-27				
Vibration resistance		Transport application test with severity level 2 to FN 942017-4 and EN 60068-2-6				

Electrical data					
Valve function		2x 2/2-way valve	2x 3/2-way valve	5/2-way valve	5/3-way valve
Electrical connection		Central plug, round design M12x1, 3-pin			
Signal status display		LED			
Characteristic coil data	Voltage	[V DC]	24		
	Power	[W]	1.3	1.3	1.6
Permissible voltage fluctuations		[%]	±10		
Duty cycle		[%]	100		
Degree of protection to EN 60529		IP65, NEMA4 (in combination with a plug socket)			

Materials	
Housing	PA
Seals	NBR, FPM
Screws	Galvanised steel
Note on materials	RoHS-compliant

Product weight		
2x 2/2-way valve	[g]	442
2x 3/2-way valve	[g]	442
5/2-way single solenoid valve	[g]	426
5/2-way double solenoid valve	[g]	439
5/3-way valve	[g]	456

Standard valves to ISO 5599-1, central plug M12, 3-pin

Technical data – Width 42 mm



Pilot pressure p12/14 as a function of working pressure p1

2x 2/2-way valve and 2x 3/2-way valve

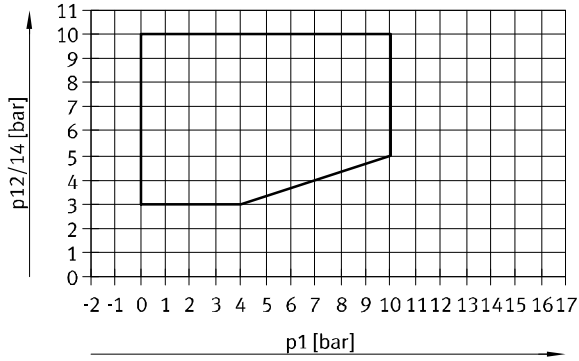

5/2-way valve and 5/3-way valve, external pilot air supply

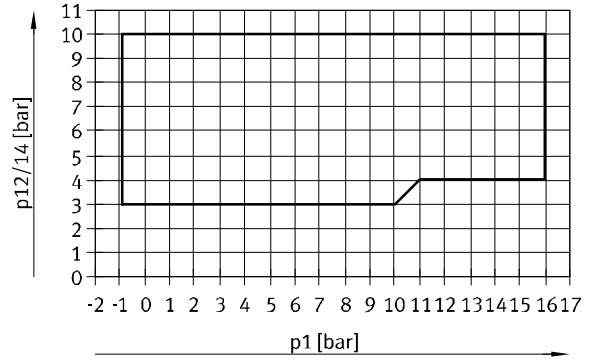

Protective circuit

Each VSVA solenoid coil is provided with a spark arresting protective circuit and protected against polarity reversal.

24 V DC version

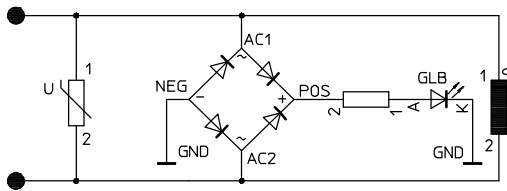

M12x1 – Pin allocation on the valve

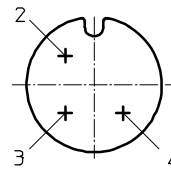

- 2 Signal (+) Solenoid 12
- 3 com (-)
- 4 Signal (+) Solenoid 14

Dimensions

Download CAD data → www.festo.com

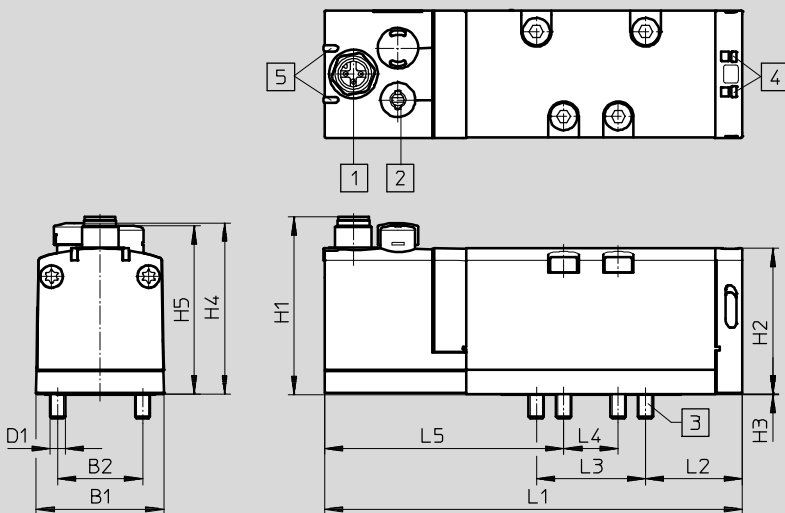

- 1 Plug, 3-pin
- 2 Manual override
- 3 Captive screws M5 x48
- 4 Slot for inscription label
- 5 LED

Type	B1	B2	D1	H1	H2	H3	H4	H5	L1	L2	L3	L4	L5
VSVA-B-...-D1-1R5L	42	28	M5	58.3	48	0.25	46.6	55.3	137.8	32	36	18	69.3

Standard valves to ISO 5599-1, central plug M12, 3-pin

Ordering data – Width 42 mm

★ Core product range

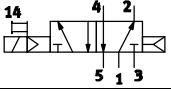
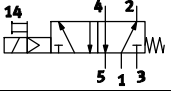
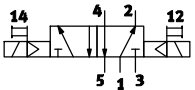
Ordering data					
Circuit symbol	Description	Direction of flow	Pilot air supply	Part No.	Type
5/2-way single solenoid valve					
	Pneumatic spring reset method	Non-reversible	Internal	★ 561362	VSVA-B-M52-AD-D1-1R5L
	Mechanical spring reset method	Non-reversible	Internal	★ 561363	VSVA-B-M52-MD-D1-1R5L
5/2-way double solenoid valve					
	Dominance at 1st signal	Non-reversible	Internal	★ 561364	VSVA-B-B52-D-D1-1R5L

Festo core product range

- ★ Ready for dispatch from the Festo factory in 24 hours
- ☆ Ready for dispatch in 5 days maximum from stock

Standard valves to ISO 5599-1, central plug M12, 3-pin

Ordering data – Width 42 mm

Ordering data					
Circuit symbol	Description	Direction of flow	Pilot air supply	Part No.	Type
2x 2/2-way valve					
	2x normally closed, pneumatic spring reset method	Non-reversible	Internal	Order via online configurator ➔ Internet: vsva	
	2x normally closed, pneumatic spring reset method	Non-reversible	External		
	2x normally closed, vacuum operation possible at 3 and 5, pneumatic spring reset method	Reversible	Internal		
2x 3/2-way valve					
	2x normally closed, pneumatic spring reset method	Non-reversible	Internal	561359	VSVA-B-T32C-AD-D1-1R5L
	2x normally closed, pneumatic spring reset method	Non-reversible	External	561369	VSVA-B-T32C-AZD-D1-1R5L
	2x normally open, pneumatic spring reset method	Non-reversible	Internal	561360	VSVA-B-T32U-AD-D1-1R5L
	2x normally open, pneumatic spring reset method	Non-reversible	External	561370	VSVA-B-T32U-AZD-D1-1R5L
	1x normally closed, 1x normally open, pneumatic spring reset method	Non-reversible	Internal	561361	VSVA-B-T32H-AD-D1-1R5L
	1x normally closed, 1x normally open, pneumatic spring reset method	Non-reversible	External	561371	VSVA-B-T32H-AZD-D1-1R5L

Standard valves to ISO 5599-1, central plug M12, 3-pin

Ordering data – Width 42 mm

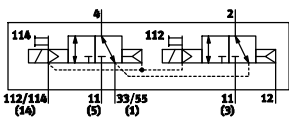
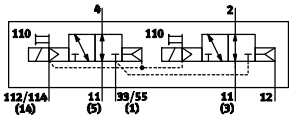
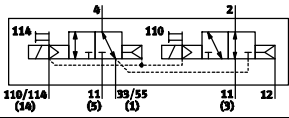
Ordering data				
Circuit symbol	Description	Direction of flow	Pilot air supply	Part No. Type
2x 3/2-way valve, reversible				
 <p>114 112/114 (14)</p> <p>4</p> <p>11 (5)</p> <p>33/55 (1)</p> <p>11 (9)</p> <p>12</p>	2x normally closed, pneumatic spring reset method	Reversible	External	Order via online configurator ➔ Internet: vsva
 <p>110 112/114 (14)</p> <p>4</p> <p>11 (5)</p> <p>33/55 (1)</p> <p>11 (9)</p> <p>12</p>	2x normally open, pneumatic spring reset method	Reversible	External	
 <p>114 110/114 (14)</p> <p>4</p> <p>11 (5)</p> <p>33/55 (1)</p> <p>11 (9)</p> <p>12</p>	1x normally closed, 1x normally open, pneumatic spring reset method	Reversible	External	

Standard valves to ISO 5599-1, central plug M12, 3-pin

Ordering data – Width 42 mm

Ordering data					
Circuit symbol	Description	Direction of flow	Pilot air supply	Part No.	Type
5/2-way single solenoid valve					
	Pneumatic spring reset method	Reversible	External	561372	VSVA-B-M52-AZD-D1-1R5L
	Mechanical spring reset method	Reversible	External	561373	VSVA-B-M52-MZD-D1-1R5L
5/2-way double solenoid valve					
	Dominance at 1st signal	Reversible	External	561374	VSVA-B-B52-ZD-D1-1R5L
	Dominant signal at 14	Non-reversible	Internal	561365	VSVA-B-D52-D-D1-1R5L
	Dominant signal at 14	Reversible	External	561375	VSVA-B-D52-ZD-D1-1R5L
5/3-way valve					
	Normally closed, mechanical spring reset method	Non-reversible	Internal	561366	VSVA-B-P53C-D-D1-1R5L
	Normally closed, mechanical spring reset method	Reversible	External	561376	VSVA-B-P53C-ZD-D1-1R5L
	Normally open, mechanical spring reset method	Non-reversible	Internal	561368	VSVA-B-P53U-D-D1-1R5L
	Normally open, mechanical spring reset method	Reversible	External	561378	VSVA-B-P53U-ZD-D1-1R5L
	Normally exhausted, mechanical spring reset method	Non-reversible	Internal	561367	VSVA-B-P53E-D-D1-1R5L
	Normally exhausted, mechanical spring reset method	Reversible	External	561377	VSVA-B-P53E-ZD-D1-1R5L

Standard valves to ISO 5599-1, central plug M12, 3-pin

Technical data – Width 52 mm

-  Flow rate
Up to 2800 l/min

-  Voltage
24 V DC



General technical data	
Design	Piston spool valve
Sealing principle	Soft
Actuation type	Electric
Type of control	Piloted
Exhaust-air function	Flow control, external or via vertically stacked flow control plate
Manual override	Non-detenting, detenting
Type of mounting	On sub-base
Mounting position	Any
Nominal size [mm]	15
No overlap	Yes
Width [mm]	52
Grid dimension [mm]	59
Pneumatic ports	Sub-base size 2 to ISO 5599-1
Conforms to standard	ISO 5599-1
Certification	c CSA us (OL)
	c UL us - Recognised (OL)
	C-Tick

Flow rates				
Valve function	2/2-way valve	3/2-way valve	5/2-way valve	5/3-way valve
Standard nominal flow rate [l/min]	2800	2200	2800	2700
Valve	4000	3000	4000	3600
Valve on individual sub-base	2400	2000	2400	2300
Valve pneumatically interlinked	2800	2200	2800	2700

Switching times [ms]					
		Switching time on	Switching time off	Switching time changeover	Switching time changeover (dominant)
2x 2/2-way valve	VSVA-B-T22...	14	35	–	–
2x 3/2-way valve	VSVA-B-T32...	20	35	–	–
2x 3/2-way valve, reversible	VSVA-B-T32...	30	30	–	–
5/2-way single solenoid valve	VSVA-B-M52-A...	40	45	–	–
	VSVA-B-M52-M...	20	60	–	–
5/2-way double solenoid valve	VSVA-B-B52...	–	–	18	–
	VSVA-B-D52...	–	–	–	18
5/3-way valve	VSVA-B-P53...	23	60	–	–

Standard valves to ISO 5599-1, central plug M12, 3-pin

FESTO

Technical data – Width 52 mm

Operating and environmental conditions						
Valve function			2x 2/2-way valve	2x 3/2-way valve	2x 3/2-way valve, reversible	5/2-way valve 5/3-way valve
Operating medium		Compressed air to ISO 8573-1:2010 [7:4:4]				
Pilot medium		Compressed air to ISO 8573-1:2010 [7:4:4]				
Note on operating/pilot medium		Lubricated operation possible (in which case lubricated operation will always be required)				
Operating pressure	Internal pilot air supply	[bar]	3 ... 10	3 ... 10	–	3 ... 10 3 ... 10
	External pilot air supply	[bar]	3 ... 10	3 ... 10	–0.9 ... +10	–0.9 ... +16 –0.9 ... +16
Pilot pressure		[bar]	3 ... 10			
Ambient temperature		[°C]	–5 ... +50			
Relative humidity		[%]	0 ... 90			

Safety characteristics	
CE marking (see declaration of conformity)	To EU EMC Directive ¹⁾
Max. positive test pulse with 0 signal	[µs] 1000
Max. negative test pulse with 1 signal	[µs] 3500
Shock resistance	Shock test with severity level 2 to FN 942017-5 and EN 60068-2-27
Vibration resistance	Transport application test with severity level 2 to FN 942017-4 and EN 60068-2-6

- 1) For information about the applicability of the component see the manufacturer's EC declaration of conformity at: www.festo.com/sp → User documentation.
If the component is subject to restrictions on usage in residential, office or commercial environments or small businesses, further measures to reduce the emitted interference may be necessary.

Electrical data			
Electrical connection		Central plug, round design M12x1, 3-pin	
Signal status display		LED	
Characteristic coil data	Voltage	[V DC]	24
	Power	[W]	4.6
Permissible voltage fluctuations		[%]	±10
Nominal pick-up current per solenoid coil		[mA]	165
Nominal current with current reduction		[mA]	35
Time until current reduction		[ms]	30
Duty cycle		[%]	100
Degree of protection to EN 60529		IP65, NEMA4 (in combination with a plug socket)	

Materials	
Housing	Die-cast aluminium, PA
Seals	HNBR, NBR, FPM
Screws	Galvanised steel
Note on materials	RoHS-compliant

Product weight		
2x 2/2-way valve	[g]	740
2x 3/2-way valve	[g]	740
5/2-way single solenoid valve	[g]	702
5/2-way double solenoid valve	[g]	732
5/3-way valve	[g]	780

Standard valves to ISO 5599-1, central plug M12, 3-pin

Technical data – Width 52 mm

Pilot pressure p12/14 as a function of working pressure p1

2x 2/2-way valve and 2x 3/2-way valve

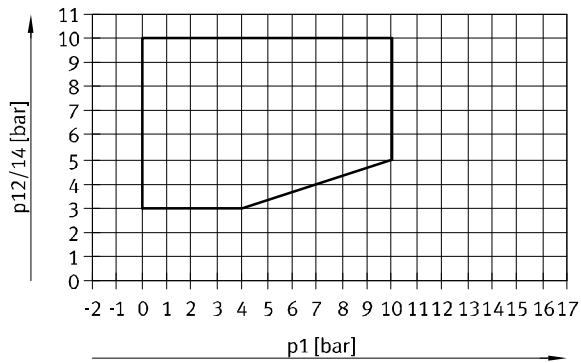

5/2-way valve and 5/3-way valve, external pilot air supply

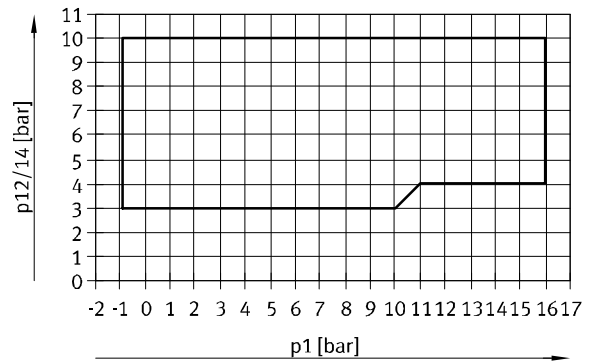

Protective circuit

Each VSVA solenoid coil is provided with a spark arresting protective circuit and protected against polarity reversal.

24 V DC version

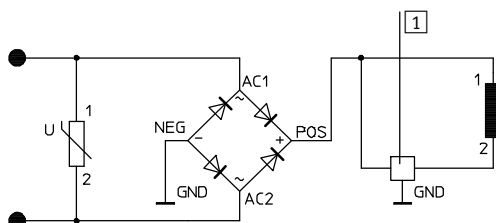

1 Reduction of holding current

M12x1 – Pin allocation on the valve

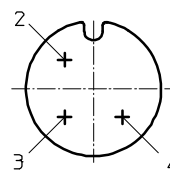

- 2 Signal (+) Solenoid 12
- 3 com (-)
- 4 Signal (+) Solenoid 14

Dimensions

Download CAD data → www.festo.com

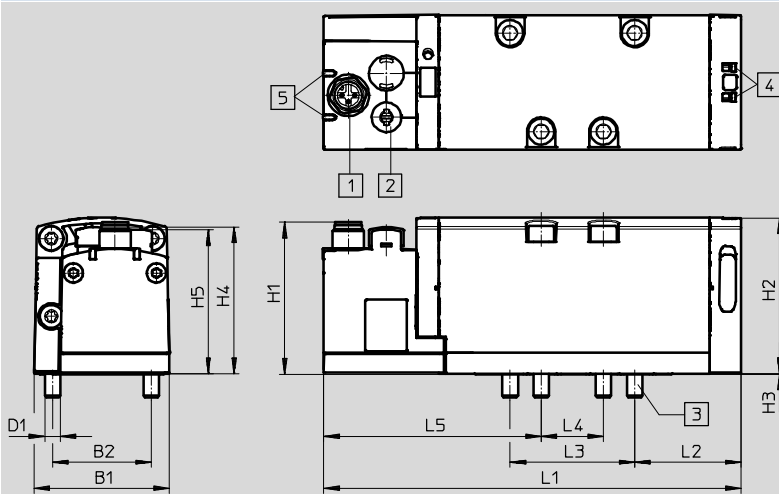

- 1 Plug, 3-pin
- 2 Manual override
- 3 Captive screws M6 x60
- 4 Slot for inscription label
- 5 LED

Type	B1	B2	D1	H1	H2	H3	H4	H5	L1	L2	L3	L4	L5
VSVA-B ...-D2-1R5L	52	38	M6	58.3	60	0.3	56.4	55.3	160.7	40.9	48	24	64.3

Standard valves to ISO 5599-1, central plug M12, 3-pin

Ordering data – Width 52 mm

Ordering data					
Circuit symbol	Description	Direction of flow	Pilot air supply	Part No.	Type
2x 2/2-way valve					
	2x normally closed, pneumatic spring reset method	Non-reversible	Internal	Order via online configurator ➔ Internet: vsva	
	2x normally closed, pneumatic spring reset method	Non-reversible	External		
2x 3/2-way valve					
	2x normally closed, pneumatic spring reset method	Non-reversible	Internal	566990	VSVA-B-T32C-AD-D2-1R5L
	2x normally closed, pneumatic spring reset method	Non-reversible	External	567000	VSVA-B-T32C-AZD-D2-1R5L
	2x normally open, pneumatic spring reset method	Non-reversible	Internal	566991	VSVA-B-T32U-AD-D2-1R5L
	2x normally open, pneumatic spring reset method	Non-reversible	External	567001	VSVA-B-T32U-AZD-D2-1R5L
	1x normally closed, 1x normally open, pneumatic spring reset method	Non-reversible	Internal	566992	VSVA-B-T32H-AD-D2-1R5L
	1x normally closed, 1x normally open, pneumatic spring reset method	Non-reversible	External	567002	VSVA-B-T32H-AZD-D2-1R5L
2x 3/2-way valve, reversible					
	2x normally closed, pneumatic spring reset method	Reversible	External	Order via online configurator ➔ Internet: vsva	
	2x normally open, pneumatic spring reset method	Reversible	External		
	1x normally closed, 1x normally open, pneumatic spring reset method	Reversible	External		

Standard valves to ISO 5599-1, central plug M12, 3-pin

Ordering data – Width 52 mm

Ordering data					
Circuit symbol	Description	Direction of flow	Pilot air supply	Part No.	Type
5/2-way single solenoid valve					
	Pneumatic spring reset method	Non-reversible	Internal	566993	VSVA-B-M52-AD-D2-1R5L
	Pneumatic spring reset method	Reversible	External	567003	VSVA-B-M52-AZD-D2-1R5L
	Mechanical spring reset method	Non-reversible	Internal	566994	VSVA-B-M52-MD-D2-1R5L
	Mechanical spring reset method	Reversible	External	567004	VSVA-B-M52-MZD-D2-1R5L
5/2-way double solenoid valve					
	Dominance at 1st signal	Non-reversible	Internal	566995	VSVA-B-B52-D-D2-1R5L
	Dominance at 1st signal	Reversible	External	567005	VSVA-B-B52-ZD-D2-1R5L
	Dominant signal at 14	Non-reversible	Internal	566996	VSVA-B-D52-D-D2-1R5L
	Dominant signal at 14	Reversible	External	567006	VSVA-B-D52-ZD-D2-1R5L
5/3-way valve					
	Normally closed, mechanical spring reset method	Non-reversible	Internal	566997	VSVA-B-P53C-D-D2-1R5L
	Normally closed, mechanical spring reset method	Reversible	External	567007	VSVA-B-P53C-ZD-D2-1R5L
	Normally open, mechanical spring reset method	Non-reversible	Internal	566999	VSVA-B-P53U-D-D2-1R5L
	Normally open, mechanical spring reset method	Reversible	External	567009	VSVA-B-P53U-ZD-D2-1R5L
	Normally exhausted, mechanical spring reset method	Non-reversible	Internal	566998	VSVA-B-P53E-D-D2-1R5L
	Normally exhausted, mechanical spring reset method	Reversible	External	567008	VSVA-B-P53E-ZD-D2-1R5L

Standard valves to ISO 5599-1, central plug M12, 4-pin

Technical data – Width 65 mm

-  - Flow rate
Up to 4600 l/min

-  - Voltage
24 V DC

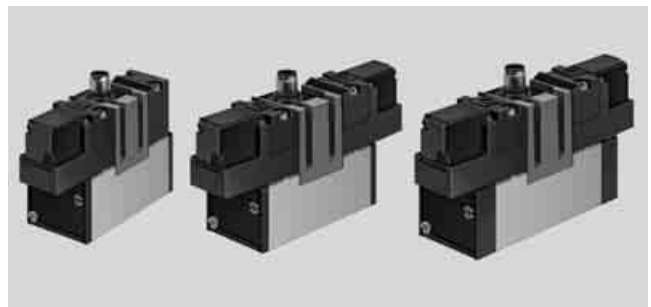

General technical data	
Design	Piston spool valve
Sealing principle	Soft
Actuation type	Electric
Type of control	Piloted
Direction of flow	Non-reversible
Exhaust function	With flow control
Manual override	Non-detenting
Type of mounting	Via through-hole
Mounting position	Any
Nominal size	[mm] 14.5
Width	[mm] 65
Grid dimension	[mm] 71
Pneumatic ports	Sub-base size 3 to ISO 5599-1
Conforms to standard	ISO 5599-1

Flow rates					
Valve function		5/2-way valve	5/3-way valve		
			Normally closed	Normally exhausted	Normally open
Standard nominal flow rate	[l/min]	4500	4100	4600	4000

Switching times [ms]					
		Switching time on	Switching time off	Switching time changeover	Switching time changeover (dominant)
5/2-way single solenoid valve	MEBH-5/2-...	59	87	-	-
	MEBH-5/2-D-1-ZSR-FR-...	28	109	-	-
5/2-way double solenoid valve	JMEBH-...	-	-	16	-
	JMEBDH-...	-	-	-	20
5/3-way valve	MEBH-5/3G-...	38	130	-	-
	MEBH-5/3E-...	38	130	-	-
	MEBH-5/3B-...	38	130	-	-

Standard valves to ISO 5599-1, central plug M12, 4-pin

Technical data – Width 65 mm

Operating and environmental conditions			
Reset method		Pneumatic spring	Mechanical spring
Operating medium		Compressed air to ISO 8573-1:2010 [7:4:4]	
Pilot medium		Compressed air to ISO 8573-1:2010 [7:4:4]	
Note on operating/pilot medium		Lubricated operation possible (in which case lubricated operation will always be required)	
Operating pressure	[bar]	2 ... 10	3 ... 10
Ambient temperature	[°C]	-5 ... +50	
Temperature of medium	[°C]	-5 ... +50	
Relative humidity	[%]	0 ... 90	

Electrical data			
Electrical connection			Central plug, round design M12x1, 4-pin
Characteristic coil data	Voltage	[V DC]	24
	Power	[W]	2.5
Degree of protection to EN 60529			IP65

Materials

Sectional view MEBH-5/2- ...

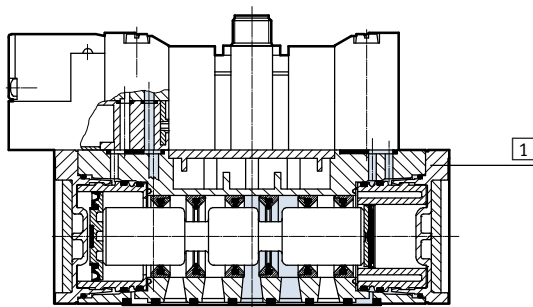

Sectional view JMEBH-5/2- ..., JMEBDH-5/2- ...

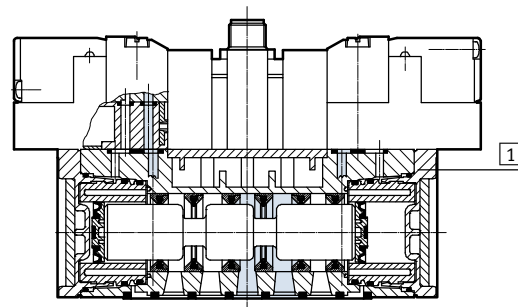

Sectional view MEBH-5/3...

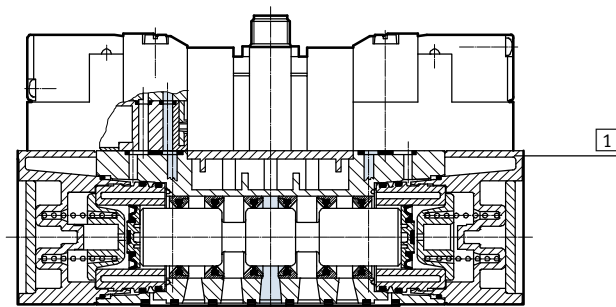

1	Housing	Die-cast aluminium
-	Seals	NBR

Standard valves to ISO 5599-1, central plug M12, 4-pin

Technical data – Width 65 mm



Dimensions

Download CAD data → www.festo.com

5/2-way single solenoid valves

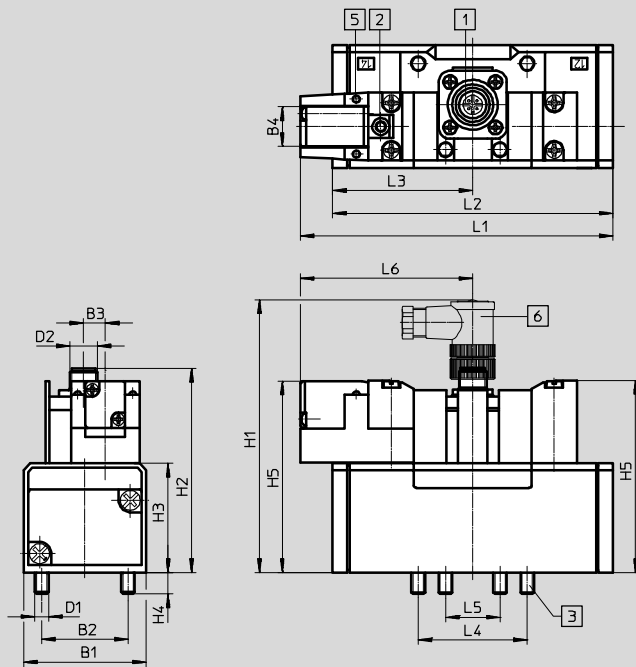

- 1 Attachment of plug socket adjustable by 3x30°
- 2 Manual override
- 3 Captive mounting screws
- 5 LED display
- 6 Angled plug socket SIE-WD-TR
→ page 122

Type	B1	B2	B3	B4	D1	D2	H1	H2	H3	H4	H5	L1	L2	L3	L4	L5	L6
MEBH-5/2 ...	65	48	12	17.5	M8	M12	130	97.8	55	12	93.1	158.7	145.4	72.7	64	32	86
MEBH-5/2- ... -FR-C												178	164.7				

5/2-way double solenoid valves, 5/3-way valves

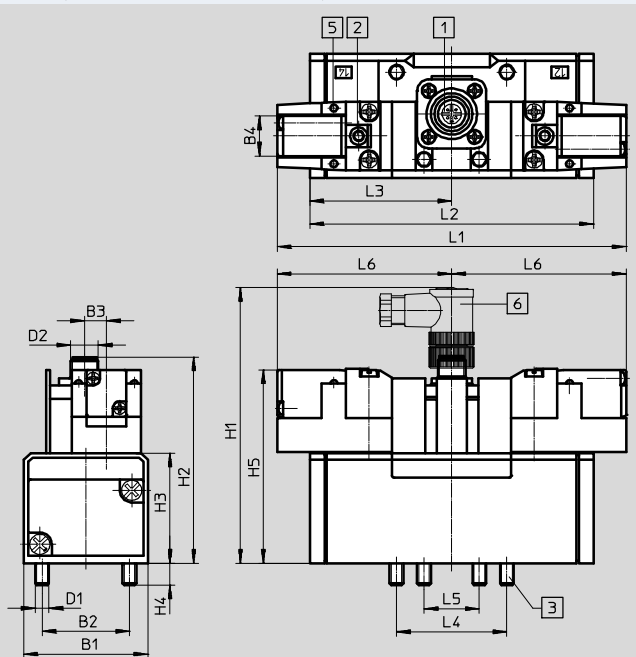

- 1 Attachment of plug socket adjustable by 3x30°
- 2 Manual override
- 3 Captive mounting screws
- 5 LED display
- 6 Angled plug socket SIE-WD-TR
→ page 122

Type	B1	B2	B3	B4	D1	D2	H1	H2	H3	H4	H5	L1	L2	L3	L4	L5	L6
JMEBH-5/2- ...	65	48	12	17.5	M8	M12	130	97.8	55	12	93.1	171.9	145.4	72.7	64	32	86
JMEBDH-5/2- ...													145.4	72.7			
MEBH-5/3...													184	92			

Standard valves to ISO 5599-1, central plug M12, 4-pin

Ordering data – Width 65 mm

Central plug M12 – Pin allocation

5/2-way single solenoid valve

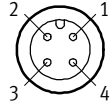

- 1 Unused
- 2 Unused
- 3 com (-)
- 4 Signal (+) Solenoid 14

5/2-way double solenoid valve and 5/3-way valve

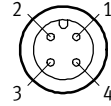

- 1 Unused
- 2 Signal (+) Solenoid 12
- 3 com (-)
- 4 Signal (+) Solenoid 14

Ordering data

Circuit symbol	Description	Pilot air supply	Weight [g]	Part No.	Type
5/2-way single solenoid valve					
	Pneumatic spring reset method	Internal	1000	184507	MEBH-5/2-D-3-ZSR-C
	Mechanical spring reset method	Internal	1000	184508	MEBH-5/2-D-3-ZSR-FR-C
5/2-way double solenoid valve					
	–	Internal	1080	184509	JMEBH-5/2-D-3-ZSR-C
	With dominant signal at 14	Internal	1080	184510	JMEBDH-5/2-D-3-ZSR-C
5/3-way valve					
	Normally closed, mechanical spring reset method	Internal	1120	184512	MEBH-5/3G-D-3-ZSR-C
	Normally exhausted, mechanical spring reset method	Internal	1120	184511	MEBH-5/3E-D-3-ZSR-C
	Normally open, mechanical spring reset method	Internal	1120	184513	MEBH-5/3B-D-3-ZSR-C

Standard valves to ISO 5599-1, individual plug M12x1

FESTO

Technical data – Width 42 mm

-  - Flow rate
1200 l/min

-  - Voltage
24 V DC



General technical data		
Design		Piston spool valve
Sealing principle		Soft
Actuation type		Electric
Type of control		Piloted
Direction of flow	With external pilot air supply	Reversible
	With internal pilot air supply	Non-reversible
Exhaust function		With flow control
Manual override		Non-detenting
Type of mounting		On sub-base via through-holes
Mounting position		Any
Nominal size	[mm]	8
No overlap		Yes
Width	[mm]	42
Grid dimension	[mm]	43
Pneumatic ports		Sub-base size 1 to ISO 5599-1
Noise level	[dB (A)]	85
Conforms to standard		ISO 5599-1

Flow rates		
Standard nominal flow rate	[l/min]	1200

Switching times [ms]					
		Switching time on	Switching time off	Switching time changeover	Switching time changeover (dominant)
5/2-way single solenoid valve	MDH-5/2-...	25	36	-	-
	MDH-5/2-...-FR-...	20	42	-	-
5/2-way double solenoid valve	JMDH-...	-	-	18	-
	JMDDH-...	-	-	18	18
5/3-way valve	MDH-5/3G-...	25	55	-	-
	MDH-5/3E-...	25	55	-	-
	MDH-5/3B-...	25	55	-	-

Standard valves to ISO 5599-1, individual plug M12x1

Technical data – Width 42 mm

Operating and environmental conditions			
Reset method		Pneumatic spring	Mechanical spring
Operating medium		Compressed air to ISO 8573-1:2010 [7:4:4]	
Pilot medium		Compressed air to ISO 8573-1:2010 [7:4:4]	
Note on operating/pilot medium		Lubricated operation possible (in which case lubricated operation will always be required)	
Operating pressure	Internal pilot air supply	[bar]	2 ... 10
	External pilot air supply	[bar]	-0.9 ... +16
Pilot pressure	Internal pilot air supply	[bar]	2 ... 10
	External pilot air supply	[bar]	3 ... 10
Ambient temperature		[°C]	-10 ... +50
Temperature of medium		[°C]	-10 ... +50

Safety characteristics		
Max. positive test pulse with 0 signal	[µs]	3800
Max. negative test pulse with 1 signal	[µs]	4900
Shock resistance	Shock test with severity level 2 to FN 942017-5 and EN 60068-2-27	
Vibration resistance	Transport application test with severity level 1 to FN 942017-4 and EN 60068-2-6	

Electrical data			
Electrical connection		M12x1	
Characteristic coil data	Voltage	[V DC]	24
	Power	[W]	2.7
Permissible voltage fluctuations		[%]	±10
Duty cycle		[%]	100
Degree of protection to EN 60529		IP65	

Standard valves to ISO 5599-1, individual plug M12x1

Technical data – Width 42 mm

Materials

Sectional view MDH-5/2- ...

Sectional view JMDH-5/2- ..., JMDDH-5/2- ...

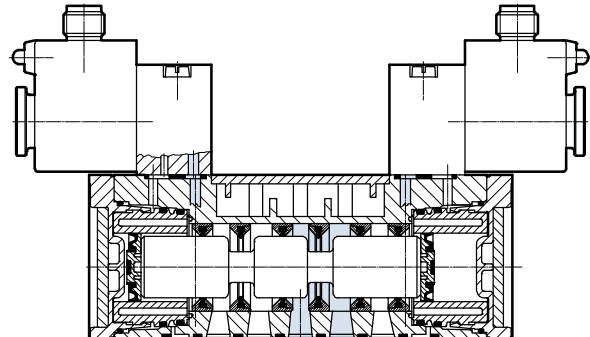
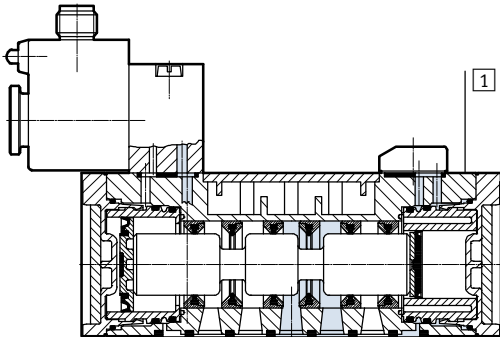

Sectional view MDH-5/3...

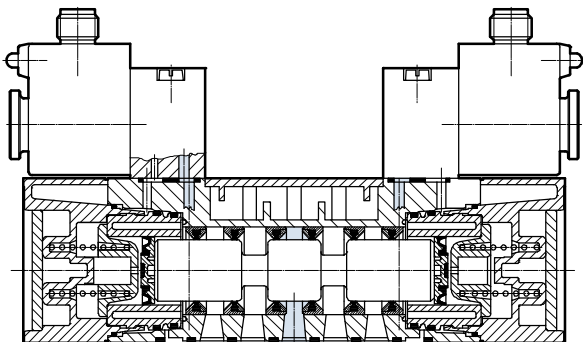

1	Housing	Die-cast aluminium
-	Seals	HNBR, NBR

Standard valves to ISO 5599-1, individual plug M12x1

Technical data – Width 42 mm

Dimensions

Download CAD data → www.festo.com

5/2-way single solenoid valves

1 Solenoid coil can be repositioned by 90° regardless of manual override
 2 Manual override
 3 Captive mounting screws
 4 Slot for inscription label
 5 LED display
 6 Device plug M12x1
 Coil, 2-pin to VDMA
 Coil, 4-pin to Desina

Type	B1	B2	B3	B4	D1	H1	H2	H3	H4	H5	L1	L2	L3	L4	L5	L6
MDH-5/2 ...	42	28	6	30	M5	87.2	77.2	38	9	46.5	121.8	87.6	43.8	36	18	-
MDH-5/2- ... -FR-...											132.2	98				

5/2-way double solenoid valves, 5/3-way valves

1 Solenoid coil can be repositioned by 90° regardless of manual override
 2 Manual override
 3 Captive mounting screws
 4 Slot for inscription label
 5 LED display
 6 Device plug M12x1
 Coil, 2-pin to VDMA
 Coil, 4-pin to Desina

Type	B1	B2	B3	B4	D1	H1	H2	H3	H4	H5	L1	L2	L3	L4	L5	L6
JMDH-5/2- ...	42	28	6	30	M5	87.2	77.2	38	9	-	148	87.6	43.8	36	18	108.5
JMDDH-5/2- ...												87.6	43.8			
MDH-5/3...												108.4	54.3			

Standard valves to ISO 5599-1, individual plug M12x1

Ordering data – Width 42 mm



Pin allocation

M12 plug – 2-pin to VDMA

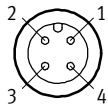

- 1 Unused
- 2 Unused
- 3 com (-)
- 4 Signal (+)

M12 plug – 4-pin to Desina

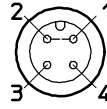

- 1 Connected to 2
- 2 Connected to 1
- 3 com (-)
- 4 Signal (+)

Ordering data – Solenoid valves

Circuit symbol	Description	Coil	Pilot air supply	Weight [g]	Part No.	Type
5/2-way single solenoid valve						
	Pneumatic spring reset method	2-pin to VDMA	Internal	420	197125	MDH-5/2-D-1-M12-C
		4-pin to Desina	Internal	420	540803	MDH-5/2-D-1-M12D-C
	Pneumatic spring reset method	2-pin to VDMA	External	420	533332	MDH-5/2-D-1-S-M12-C
		4-pin to Desina	External	420	540810	MDH-5/2-D-1-S-M12D-C
	Mechanical spring reset method	2-pin to VDMA	Internal	420	533010	MDH-5/2-D-1-FR-M12-C
		4-pin to Desina	Internal	420	540804	MDH-5/2-D-1-FR-M12D-C
	Mechanical spring reset method	2-pin to VDMA	External	420	533761	MDH-5/2-D-1-S-FR-M12-C
		4-pin to Desina	External	420	540811	MDH-5/2-D-1-S-FR-M12D-C
5/2-way double solenoid valve						
	-	2-pin to VDMA	Internal	550	532687	JMDH-5/2-D-1-M12-C
		4-pin to Desina	Internal	550	540809	JMDH-5/2-D-1-M12D-C
	With dominant signal at 14	2-pin to VDMA	Internal	550	539079	JMDDH-5/2-D-1-M12-C
		4-pin to Desina	Internal	550	540808	JMDDH-5/2-D-1-M12D-C
5/3-way valve						
	Normally closed, mechanical spring reset method	2-pin to VDMA	Internal	580	525307	MDH-5/3G-D-1-M12-C
		4-pin to Desina	Internal	580	540806	MDH-5/3G-D-1-M12D-C
	Normally exhausted, mechanical spring reset method	2-pin to VDMA	Internal	580	197126	MDH-5/3E-D-1-M12-C
		4-pin to Desina	Internal	580	540805	MDH-5/3E-D-1-M12D-C
	Normally open, mechanical spring reset method	2-pin to VDMA	Internal	580	533005	MDH-5/3B-D-1-M12-C
		4-pin to Desina	Internal	580	540807	MDH-5/3B-D-1-M12D-C

Standard valves to ISO 5599-1, individual plug M12x1

Technical data – Width 52 mm

-  - Flow rate
2300 l/min

-  - Voltage
24 V DC



General technical data	
Design	Piston spool valve
Sealing principle	Soft
Actuation type	Electric
Type of control	Piloted
Direction of flow	Non-reversible
Exhaust function	With flow control
Manual override	Non-detenting
Type of mounting	On sub-base, with through-hole and screw
Mounting position	Any
Nominal size [mm]	11.5
No overlap	Yes
Width [mm]	52
Grid dimension [mm]	56
Pneumatic ports	Sub-base size 2 to ISO 5599-1
Noise level [dB (A)]	85
Conforms to standard	ISO 5599-1

Flow rates	
Standard nominal flow rate [l/min]	2300

Switching times [ms]					
		Switching time on	Switching time off	Switching time changeover	Switching time changeover (dominant)
5/2-way single solenoid valve	MDH-5/2-...	45	60	-	-
	MDH-5/2-...-FR-...	25	60	-	-
5/2-way double solenoid valve	JMDH-...	-	-	20	-
	JMDDH-...	-	-	20	20
5/3-way valve	MDH-5/3G-...	35	70	-	-
	MDH-5/3E-...	35	70	-	-
	MDH-5/3B-...	35	70	-	-

Standard valves to ISO 5599-1, individual plug M12x1

Technical data – Width 52 mm

Operating and environmental conditions		
Reset method		Pneumatic spring Mechanical spring
Operating medium		Compressed air to ISO 8573-1:2010 [7:4:4]
Note on operating/pilot medium		Lubricated operation possible (in which case lubricated operation will always be required)
Operating pressure	[bar]	2 ... 10 3 ... 10
Ambient temperature	[°C]	-10 ... +50
Temperature of medium	[°C]	-10 ... +50

Safety characteristics		
Max. positive test pulse with 0 signal	[µs]	3800
Max. negative test pulse with 1 signal	[µs]	4900
Shock resistance		Shock test with severity level 2 to FN 942017-5 and EN 60068-2-27
Vibration resistance		Transport application test with severity level 1 to FN 942017-4 and EN 60068-2-6

Electrical data			
Electrical connection			M12x1
Characteristic coil data	Voltage	[V DC]	24
	Power	[W]	2.7
Permissible voltage fluctuations		[%]	±10
Duty cycle		[%]	100
Degree of protection to EN 60529			IP65

Materials

Sectional view MDH-5/2- ...

Sectional view JMDH-5/2- ..., JMDDH-5/2- ...

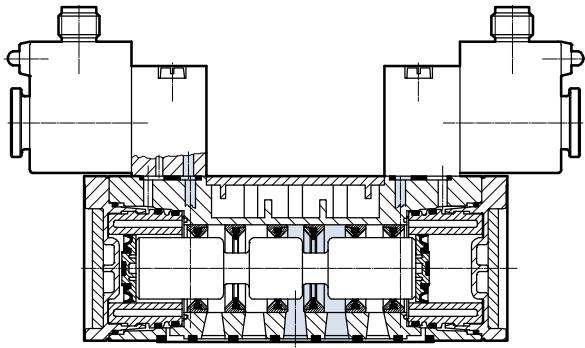
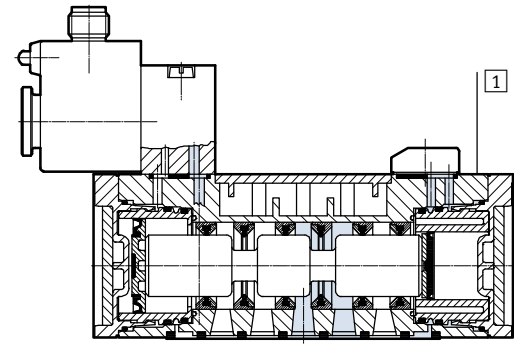

Sectional view MDH-5/3...

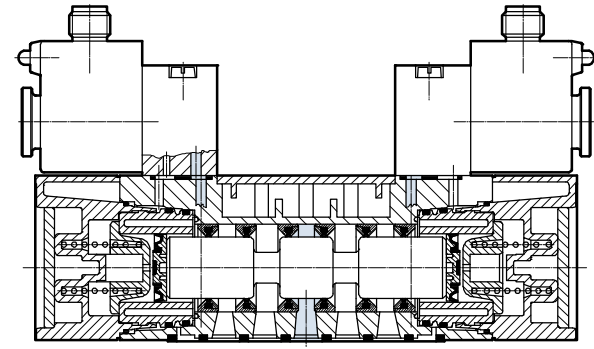

1	Housing	Die-cast aluminium
-	Seals	HNBR, NBR
-	Note on materials	RoHS-compliant

Standard valves to ISO 5599-1, individual plug M12x1

Technical data – Width 52 mm

Dimensions

Download CAD data → www.festo.com

5/2-way single solenoid valves

1 Solenoid coil can be repositioned by 90° regardless of manual override
 2 Manual override
 3 Captive mounting screws
 4 Slot for inscription label
 5 LED display
 6 Device plug M12x1
 Coil, 2-pin to VDMA
 Coil, 4-pin to Desina

Type	B1	B2	B3	B4	D1	H1	H2	H3	H4	H5	L1	L2	L3	L4	L5	L6
MDH-5/2 ...	54	38	9	30	M6	97.2	87.2	48	9.5	56.5	144.6	123.4	61.7	48	24	-
MDH-5/2- ... -FR...											161.9	140.6				

5/2-way double solenoid valves, 5/3-way valves

1 Solenoid coil can be repositioned by 90° regardless of manual override
 2 Manual override
 3 Captive mounting screws
 4 Slot for inscription label
 5 LED display
 6 Device plug M12x1
 Coil, 2-pin to VDMA
 Coil, 4-pin to Desina

Type	B1	B2	B3	B4	D1	H1	H2	H3	H4	H5	L1	L2	L3	L4	L5	L6
JMDH-5/2- ...	54	38	9	30	M6	97.2	87.2	48	9.5	-	165.8	123.4	61.7	48	24	126.3
JMDDH-5/2- ...											123.4	61.7				
MDH-5/3...											158	79				

Standard valves to ISO 5599-1, individual plug M12x1

Ordering data – Width 52 mm



Pin allocation

M12 plug – 2-pin to VDMA

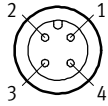

- 1 Unused
- 2 Unused
- 3 com (-)
- 4 Signal (+)

M12 plug – 4-pin to Desina

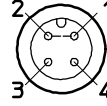

- 1 Connected to 2
- 2 Connected to 1
- 3 com (-)
- 4 Signal (+)

Ordering data

Circuit symbol	Description	Coil	Pilot air supply	Weight [g]	Part No.	Type
5/2-way single solenoid valve						
	Pneumatic spring reset method	2-pin to VDMA	Internal	810	533008	MDH-5/2-D-2-M12-C
		4-pin to Desina	Internal	810	540812	MDH-5/2-D-2-M12D-C
	Mechanical spring reset method	2-pin to VDMA	Internal	810	533011	MDH-5/2-D-2-FR-M12-C
		4-pin to Desina	Internal	810	540813	MDH-5/2-D-2-FR-M12D-C
5/2-way double solenoid valve						
	-	2-pin to VDMA	Internal	940	533013	JMDH-5/2-D-2-M12-C
		4-pin to Desina	Internal	940	540818	JMDH-5/2-D-2-M12D-C
	With dominant signal at 14	2-pin to VDMA	Internal	940	539077	JMDDH-5/2-D-2-M12-C
		4-pin to Desina	Internal	940	540817	JMDDH-5/2-D-2-M12D-C
5/3-way valve						
	Normally closed, mechanical spring reset method	2-pin to VDMA	Internal	1000	539078	MDH-5/3G-D-2-M12-C
		4-pin to Desina	Internal	1000	540815	MDH-5/3G-D-2-M12D-C
	Normally exhausted, mechanical spring reset method	2-pin to VDMA	Internal	1000	533016	MDH-5/3E-D-2-M12-C
		4-pin to Desina	Internal	1000	540814	MDH-5/3E-D-2-M12D-C
	Normally open, mechanical spring reset method	2-pin to VDMA	Internal	1000	533006	MDH-5/3B-D-2-M12-C
		4-pin to Desina	Internal	1000	540816	MDH-5/3B-D-2-M12D-C

Standard valves to ISO 5599-1, individual plug M12x1

Technical data – Width 65 mm

-  - Flow rate
4500 l/min

-  - Voltage
24 V DC



General technical data	
Design	Piston spool valve
Sealing principle	Soft
Actuation type	Electric
Type of control	Piloted
Direction of flow	Non-reversible
Exhaust function	With flow control
Manual override	Non-detenting
Type of mounting	On sub-base, with through-hole and screw
Mounting position	Any
Nominal size [mm]	14.5
No overlap	Yes
Width [mm]	65
Grid dimension [mm]	71
Pneumatic ports	Sub-base size 3 to ISO 5599-1
Noise level [dB (A)]	85
Conforms to standard	ISO 5599-1

Flow rates				
Valve function	5/2-way valve	5/3-way valve		
		Normally closed	Normally exhausted	Normally open
Standard nominal flow rate [l/min]	4500	4100	4600	4000

Switching times [ms]					
		Switching time on	Switching time off	Switching time changeover	Switching time changeover (dominant)
5/2-way single solenoid valve	MDH-5/2-...	54	57	-	-
	MDH-5/2-...-FR-...	28	68	-	-
5/2-way double solenoid valve	JMDH-...	-	-	21	-
	JMDDH-...	-	-	23	23
5/3-way valve	MDH-5/3G-...	35	79	-	-
	MDH-5/3E-...	36	84	-	-
	MDH-5/3B-...	36	84	-	-

Standard valves to ISO 5599-1, individual plug M12x1

Technical data – Width 65 mm

Operating and environmental conditions		
Reset method		Pneumatic spring Mechanical spring
Operating medium		Compressed air to ISO 8573-1:2010 [7:4:4]
Note on operating/pilot medium		Lubricated operation possible (in which case lubricated operation will always be required)
Operating pressure	[bar]	2 ... 10 3 ... 10
Ambient temperature	[°C]	-10 ... +50
Temperature of medium	[°C]	-10 ... +50

Safety characteristics		
Max. positive test pulse with 0 signal	[µs]	3800
Max. negative test pulse with 1 signal	[µs]	4900
Shock resistance		Shock test with severity level 2 to FN 942017-5 and EN 60068-2-27
Vibration resistance		Transport application test with severity level 1 to FN 942017-4 and EN 60068-2-6

Electrical data			
Electrical connection			M12x1
Characteristic coil data	Voltage	[V DC]	24
	Power	[W]	2.7
Permissible voltage fluctuations		[%]	±10
Duty cycle		[%]	100
Degree of protection to EN 60529			IP65

Materials

Sectional view MDH-5/2- ...

Sectional view JMDH-5/2- ..., JMDDH-5/2- ...

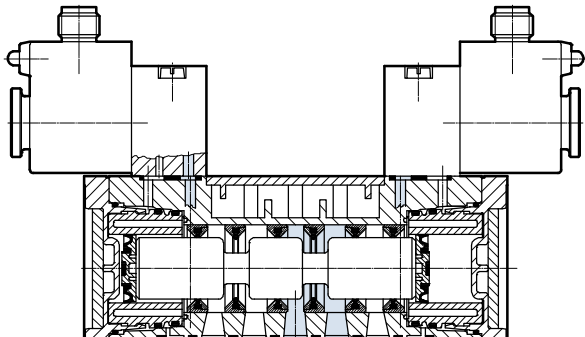
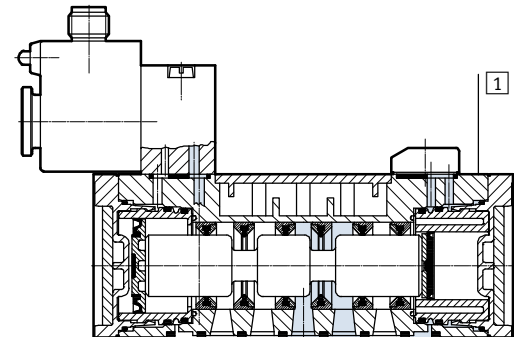

Sectional view MDH-5/3...

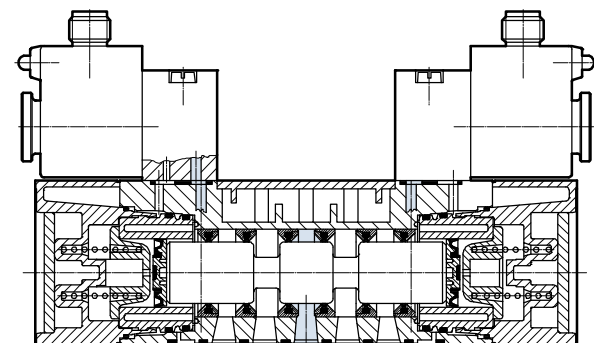

1	Housing	Die-cast aluminium
-	Seals	HNBR, NBR
-	Note on materials	RoHS-compliant

Standard valves to ISO 5599-1, individual plug M12x1

Technical data – Width 65 mm

Dimensions

Download CAD data → www.festo.com

5/2-way single solenoid valves

1 Solenoid coil can be repositioned by 90° regardless of manual override
 2 Manual override
 3 Captive mounting screws
 4 Slot for inscription label
 5 LED display
 6 Device plug M12x1
 Coil, 2-pin to VDMA
 Coil, 4-pin to Desina

Type	B1	B2	B3	B4	D1	H1	H2	H3	H4	H5	L1	L2	L3	L4	L5	L6
MDH-5/2 ...	65	48	12	30	M8	104.2	94.2	55	12	62.5	165.9	145.4	72.7	64	32	-
MDH-5/2- ... -FR...											182.5	140.6				

5/2-way double solenoid valves, 5/3-way valves

1 Solenoid coil can be repositioned by 90° regardless of manual override
 2 Manual override
 3 Captive mounting screws
 4 Slot for inscription label
 5 LED display
 6 Device plug M12x1
 Coil, 2-pin to VDMA
 Coil, 4-pin to Desina

Type	B1	B2	B3	B4	D1	H1	H2	H3	H4	H5	L1	L2	L3	L4	L5	L6
JMDH-5/2- ...	65	48	12	30	M8	104.2	94.2	55	12	-	186.4	145.4	72.7	64	32	146.9
JMDDH-5/2- ...											145.4	72.7				
MDH-5/3...											184	92				

Standard valves to ISO 5599-1, individual plug M12x1

Ordering data – Width 65 mm



Pin allocation

M12 plug – 2-pin to VDMA

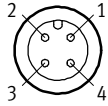

- 1 Unused
- 2 Unused
- 3 com (-)
- 4 Signal (+)

M12 plug – 4-pin to Desina

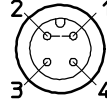

- 1 Connected to 2
- 2 Connected to 1
- 3 com (-)
- 4 Signal (+)

Ordering data

Circuit symbol	Description	Coil	Pilot air supply	Weight [g]	Part No.	Type
5/2-way single solenoid valve						
	Pneumatic spring reset method	2-pin to VDMA	Internal	1000	533009	MDH-5/2-D-3-M12-C
		4-pin to Desina	Internal	1000	540819	MDH-5/2-D-3-M12D-C
	Mechanical spring reset method	2-pin to VDMA	Internal	1000	533012	MDH-5/2-D-3-FR-M12-C
		4-pin to Desina	Internal	1000	540820	MDH-5/2-D-3-FR-M12D-C
5/2-way double solenoid valve						
	-	2-pin to VDMA	Internal	1100	533015	JMDH-5/2-D-3-M12-C
		4-pin to Desina	Internal	1100	540825	JMDH-5/2-D-3-M12D-C
	With dominant signal at 14	2-pin to VDMA	Internal	1100	539081	JMDDH-5/2-D-3-M12-C
		4-pin to Desina	Internal	1100	540824	JMDDH-5/2-D-3-M12D-C
5/3-way valve						
	Normally closed, mechanical spring reset method	2-pin to VDMA	Internal	1120	539080	MDH-5/3G-D-3-M12-C
		4-pin to Desina	Internal	1120	540822	MDH-5/3G-D-3-M12D-C
	Normally exhausted, mechanical spring reset method	2-pin to VDMA	Internal	1120	533017	MDH-5/3E-D-3-M12-C
		4-pin to Desina	Internal	1120	540821	MDH-5/3E-D-3-M12D-C
	Normally open, mechanical spring reset method	2-pin to VDMA	Internal	1120	533007	MDH-5/3B-D-3-M12-C
		4-pin to Desina	Internal	1120	540823	MDH-5/3B-D-3-M12D-C

Standard valves to ISO 5599-1, square plug design A

Technical data – Width 76 mm

-  - Flow rate
Up to 6000 l/min

-  - Voltage
24 V DC
48 V AC



General technical data	
Design	Piston spool valve
Sealing principle	Soft
Actuation type	Electric
Type of control	Piloted
Direction of flow	Non-reversible
Exhaust function	With flow control
Manual override	Non-detenting
Type of mounting	On sub-base, with through-hole and screw
Mounting position	Any
Nominal size [mm]	18
No overlap	Yes
Width [mm]	76
Grid dimension [mm]	82
Pneumatic ports	Sub-base size 4 to ISO 5599-1
Noise level [dB (A)]	85
Conforms to standard	ISO 5599-1

Flow rates		
Valve function	5/2-way valve	5/3-way valve
Standard nominal flow rate [l/min]	6000	4800

Switching times [ms]				
		Switching time on	Switching time off	Switching time changeover
5/2-way valve	Single solenoid valve	120	160	–
	Double solenoid valve	–	–	40
5/3-way valve		85	290	–

Standard valves to ISO 5599-1, square plug design A

FESTO

Technical data – Width 76 mm

Operating and environmental conditions				
Valve function		5/2-way single solenoid valve	5/2-way double solenoid valve	5/3-way valve
Operating medium		Compressed air to ISO 8573-1:2010 [7:4:4]		
Note on operating/pilot medium		Lubricated operation possible (in which case lubricated operation will always be required)		
Operating pressure	[bar]	3 ... 16	2 ... 16	3 ... 16
Ambient temperature	[°C]	-10 ... +50		
Temperature of medium	[°C]	-10 ... +60		

Safety characteristics			
Type		MDH-...-D-4-24DC, JMDH-...-D-4-24DC	MDH-...-D-4, JMDH-...-D-4
Max. positive test pulse with 0 signal	[µs]	4300	-
Max. negative test pulse with 1 signal	[µs]	2100	-

Electrical data – MDH-...-24DC, JMDH-...-24DC				
		Direct voltage	Alternating voltage	
Electrical connection		To DIN EN 175301-803		
Characteristic coil data	Voltage	[V DC]	24	-
		[AC V]	-	48
	Frequency	[Hz]	-	50/60
	Power	[W]	6.8	-
	Pick-up power	[VA]	-	14.5
	Holding power	[VA]	-	9.9
Duty cycle	[%]	100		
Degree of protection to EN 60529		IP65		

Electrical data – Pilot valve MDH-3/2-...													
		MDH-3/2-24DC			MDH-3/2-24DC/42AC			MDH-3/2-110AC		MDH-3/2-230AC			
Electrical connection		Plug, square design to EN 175301-803, type A											
Characteristic coil data	Voltage	[V DC]	24	-	-	24	-	-	-	-	110	-	-
		[AC V]	-	48	53	-	42	42	110	110	-	230	230
	Frequency	[Hz]	-	50	60	-	50	60	50	60	-	50	60
	Power	[W]	6.8	-	-	8.4	-	-	-	-	6.3	-	-
	Pick-up power	[VA]	-	14.5	15	-	14	12	14.5	12	-	14.5	12
	Holding power	[VA]	-	9.9	9.3	-	10	7	10.5	7.6	-	10.5	7.6
Permissible voltage fluctuations		[%]	±10	±10	±10	±10	±10	±10	±10	±10	±10	±10	±10
Permissible frequency fluctuations		[%]	-	-	-	±10	±10	±10	±10	±10	±10	±10	±10
Duty cycle		[%]	100										
Degree of protection to EN 60529		IP65											

Standard valves to ISO 5599-1, square plug design A

Technical data – Width 76 mm

Materials

Sectional view MDH-5/2- ...

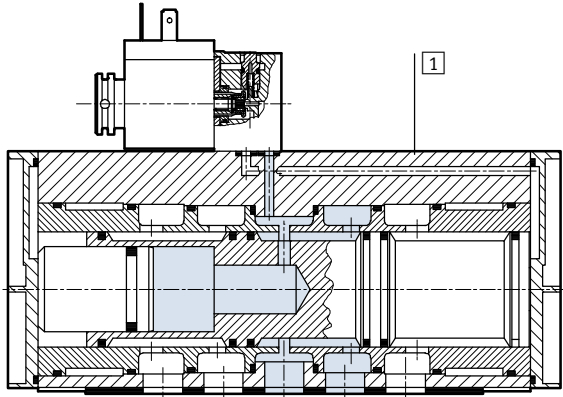

Sectional view JMDH-5/2- ...

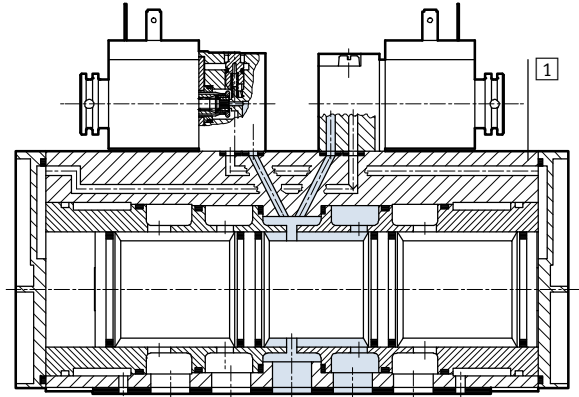

Sectional view MDH-5/3...

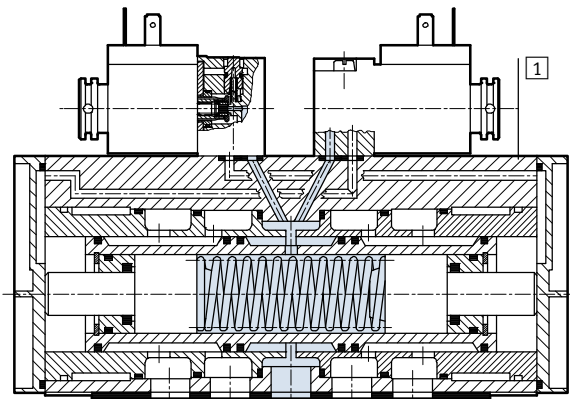

1	Housing	Aluminium
-	Seals	NBR
-	Note on materials	RoHS-compliant

Standard valves to ISO 5599-1, square plug design A

Technical data – Width 76 mm

Dimensions

Download CAD data → www.festo.com

5/2-way single solenoid valves

1 Port for plug socket with port pattern to EN 175301-803, type A
→ page 121

2 Manual override

3 Captive mounting screws

4 Solenoid coil can be repositioned by 90° regardless of manual override

Type	B1	B2	D1	H1	H2	H3	H4	L1	L2	L3	L4	L5
MDH-5/2 ...	76	58	M8	139	110.5	74	14	182	67.5	80	40	81

5/2-way double solenoid valves, 5/3-way valves

1 Port for plug socket with port pattern to EN 175301-803, type A
→ page 121

2 Manual override



3 Captive mounting screws

4 Solenoid coil can be repositioned by 90° regardless of manual override

Type	B1	B2	D1	H1	H2	H3	H4	L1	L2	L3	L4	L5
JMDH-5/2- ...	76	58	M8	139	110.5	74	14	182	135	80	40	162
MDH-5/3...									135			

Standard valves to ISO 5599-1, square plug design A

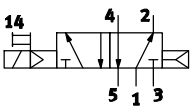
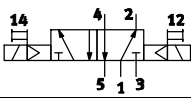
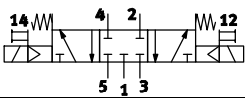
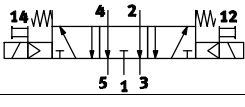
Ordering data – Width 76 mm

Ordering data						
Circuit symbol	Description	Voltage	Pilot air supply	Weight [g]	Part No.	Type
5/2-way single solenoid valve						
	Pneumatic spring reset method	24 V DC	Internal	2600	12457	MDH-5/2-3/4-D-4-24DC
		–	Internal	2600	14544	MDH-5/2-3/4-D-4¹⁾
5/2-way double solenoid valve						
	–	24 V DC	Internal	2600	12458	JMDH-5/2-3/4-D-4-24DC
		–	Internal	2600	14545	JMDH-5/2-3/4-D-4¹⁾
5/3-way valve						
	Normally closed, mechanical spring reset method	24 V DC	Internal	2600	12459	MDH-5/3G-3/4-D-4-24DC
		–	Internal	2600	14546	MDH-5/3G-3/4-D-4¹⁾
	Normally exhausted, mechanical spring reset method	24 V DC	Internal	2600	12460	MDH-5/3E-3/4-D-4-24DC
		–	Internal	2600	14547	MDH-5/3E-3/4-D-4¹⁾
Usable pilot valves						
	Electrical connection to EN 175301-803 design A	24 V DC	–	140	119600	MDH-3/2-24DC
		24 V DC/42 V AC	–	140	119603	MDH-3/2-24DC/42AC
		110 V AC	–	140	119601	MDH-3/2-110AC
		110 V DC/230 V AC	–	140	119602	MDH-3/2-230AC

1) Without pilot valve. The part no. of the pilot valve must be added after the type code when ordering.
Order example: 14546 MDH-5/3G-3/4-D-4-119602 (for MDH-3/2-230AC with part no. 119602)

Standard valves to ISO 5599-1, pneumatic valves

Type codes

VL - 5/3 G - D-1 - - C

Type

VL	Monostable
J	Bistable
JD	Bistable, with dominant signal

Valve function

5/2	5/2-way valve
5/3	5/3-way valve

Initial position

G	Closed
E	Exhausted
B	Pressurised

Size

D-1	ISO size 1
D-2	ISO size 2
D-3	ISO size 3
¾-D-4	ISO size 4

Reset method

FR	Mechanical spring (for 5/2 valves)
	Pneumatic spring

Generation

C	C series
---	----------

Standard valves to ISO 5599-1, pneumatic valves

Peripherals overview

Valve on individual sub-base

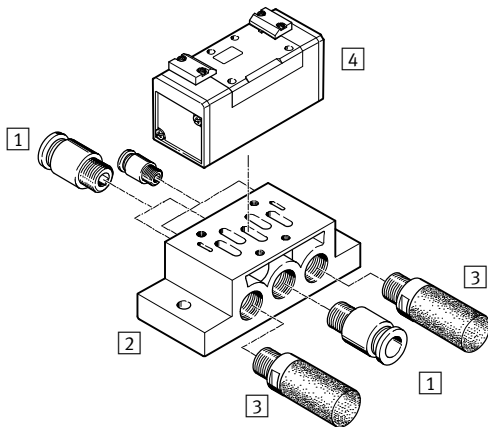

Individual components			
	Type	Description	→ Page/Internet
1	Push-in fitting	QS-...	For connecting O.D. tubing qs
2	Individual sub-base	NAS-...	Pneumatic ports, side 100
		NAU-...	Pneumatic ports, underneath 101
3	Silencer	U-...	For fitting in exhaust ports silencer
4	Pneumatic valve	VL-...	Port pattern to ISO 5599-1 81
		J-...	Port pattern to ISO 5599-1 81
		JD-...	Port pattern to ISO 5599-1 81

Standard valves to ISO 5599-1, pneumatic valves

Peripherals overview

Manifold assembly

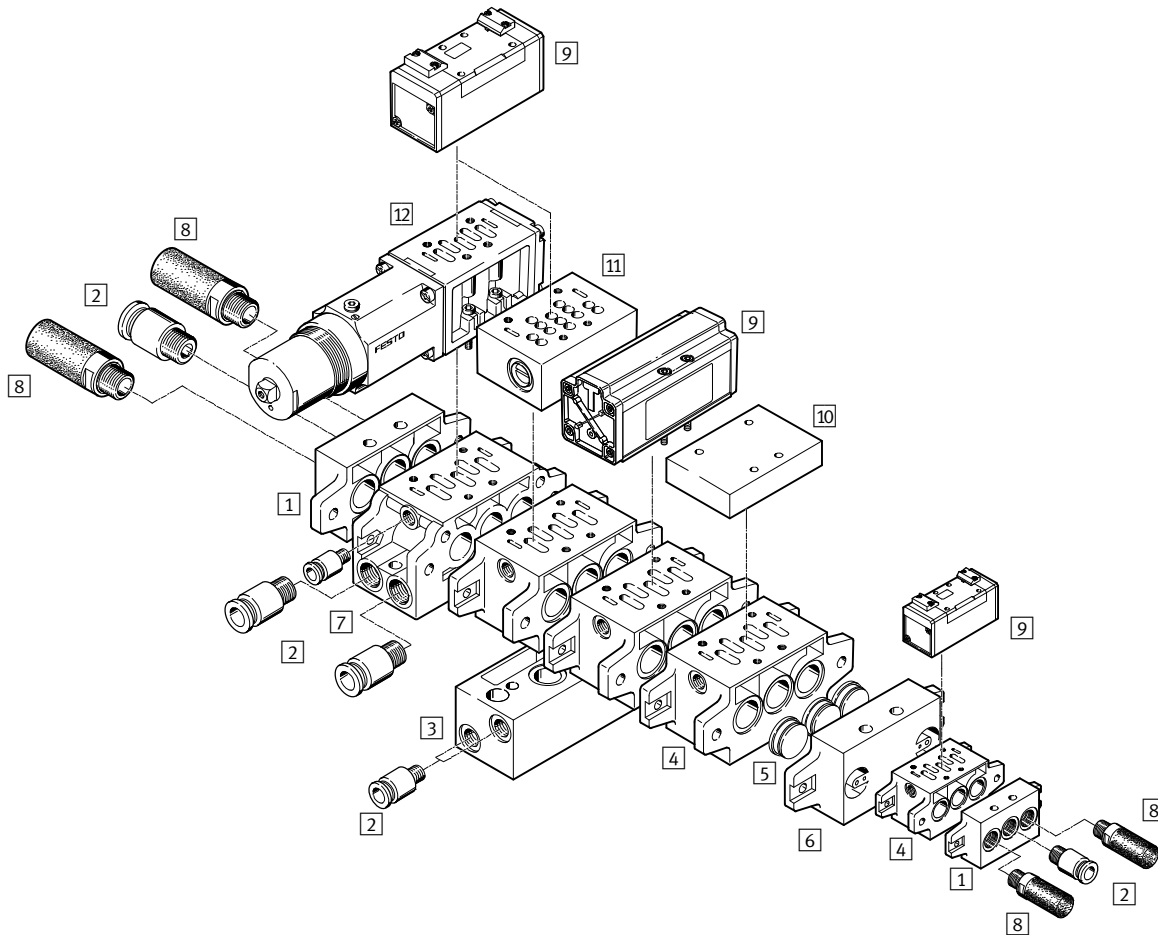

Individual components			
	Type	Description	→ Page/Internet
1	NEV-...	For sealing the manifold sub-bases	103
2	QS-...	For connecting O.D. tubing	qs
3	NAW-...	For routing ports 2 and 4 to the front	102
4	NAV-...	With ports 2 and 4 underneath	102
5	NSC-...	For sealing ducts 1, 3, 5 between end plate and manifold sub-base, e.g. to create pressure zones	104
6	NZV-...	For connecting manifold sub-bases of different sizes	106
7	NAVW-...	With ports 2 and 4 either underneath or to the front	103
8	U-...	For fitting in exhaust ports	silencer
9	VL-...	Port pattern to ISO 5599-1	81
	J-...	Port pattern to ISO 5599-1	81
	JD-...	Port pattern to ISO 5599-1	81
10	NDV-...	For sealing unused manifold sub-bases	104
11	VABF-S1-...-F1B1-C	Controls the flow of exhaust air in ducts 3 and 5	107
	GRO-ZP-...	Controls the flow of exhaust air in ducts 3 and 5	107
12	VABF-S1-...-R...	Pressure regulator for manually setting a particular pressure in the regulated port upstream or downstream of the valve	114
	LR-ZP-...	Pressure regulator for manually setting a particular pressure in the regulated port upstream or downstream of the valve	114

Standard valves to ISO 5599-1, pneumatic valves

Technical data – Width 42 mm

 Flow rate
 1200 l/min



General technical data		
Type	VL- ... -C, J ... -C	VL- ... -EX, J ... -EX
Design	Piston spool valve	Piston spool valve
Sealing principle	Soft	Soft
Actuation type	Pneumatic	Pneumatic
Type of control	Direct	Direct
Direction of flow	Reversible	Reversible
	VL-5/2-D-1-C: non-reversible	VL-5/2-D-1-C-EX: non-reversible
Exhaust function	With flow control	With flow control
Manual override	None	None
Type of mounting	On sub-base via through-hole	On sub-base via through-hole
Mounting position	Any	Any
Nominal size [mm]	8	8
No overlap	Yes	Yes
Width [mm]	42	42
Grid dimension [mm]	43	43
Pneumatic ports	Sub-base size 1 to ISO 5599-1	Sub-base size 1 to ISO 5599-1
Noise level [dB (A)]	85	85
Conforms to standard	ISO 5599-1	ISO 5599-1
Certification	UL Recognised (OL)	–
Maritime classification ¹⁾	See certificate	–

1) Additional information www.festo.com/sp → Certificates.

Flow rates		
Standard nominal flow rate	[l/min]	1200

Switching times [ms]					
		Switching time on	Switching time off	Switching time changeover	Switching time changeover (dominant)
5/2-way single solenoid valve	VL-5/2-D-1-C	9	18	–	–
	VL-5/2-D-1-C-EX	9	18	–	–
	VL-5/2-D-1-FR-C	6	23	–	–
	VL-5/2-D-1-FR-C-EX	6	23	–	–
5/2-way double solenoid valve	J-5/2-D-1-C	–	–	6	–
	J-5/2-D-1-C-EX	–	–	6	–
	JD-5/2-D-1-C	–	–	6	4
	JD-5/2-D-1-C-EX	–	–	6	4
5/3-way valve	VL-5/3G-D-1-C	7	44	–	–
	VL-5/3G-D-1-C-EX	7	44	–	–
	VL-5/3E-D-1-C	7	45	–	–
	VL-5/3E-D-1-C-EX	7	45	–	–
	VL-5/3B-D-1-C	7	44	–	–
	VL-5/3B-D-1-C-EX	7	44	–	–

Standard valves to ISO 5599-1, pneumatic valves

Technical data – Width 42 mm

ATEX	
Type	VL- ... -EX, J ... -EX
ATEX category gas	II 2G
Ignition protection type for gas	c T4
ATEX category for dust	II 2D
Ignition protection type for dust	c T130°C
Explosion-proof ambient temperature [°C]	-10 ≤ Ta ≤ +60
CE marking (see declaration of conformity)	As per EU Explosion Protection Directive (ATEX)

Operating and environmental conditions					
Valve function	5/2-way valve			5/3-way valve	
	Single solenoid valve		Double solenoid valve		
	Pneumatic spring	Mechanical spring			
Operating medium	Compressed air to ISO 8573-1:2010 [7:4:4]				
Pilot medium	Compressed air to ISO 8573-1:2010 [7:4:4]				
Note on operating/pilot medium	Lubricated operation possible (in which case lubricated operation will always be required)				
Operating pressure [bar]	2 ... 16	-0.9 ... +16	-0.9 ... +16	-0.9 ... +16	
Pilot pressure [bar]	2 ... 16	3 ... 16	2 ... 16	3 ... 16	
Ambient temperature [°C]	-10 ... +60				
Temperature of medium [°C]	-10 ... +60				

Safety characteristics	
Shock resistance	Shock test with severity level 2 to FN 942017-5 and EN 60068-2-27
Vibration resistance	Transport application test with severity level 1 to FN 942017-4 and EN 60068-2-6

Materials

Sectional view

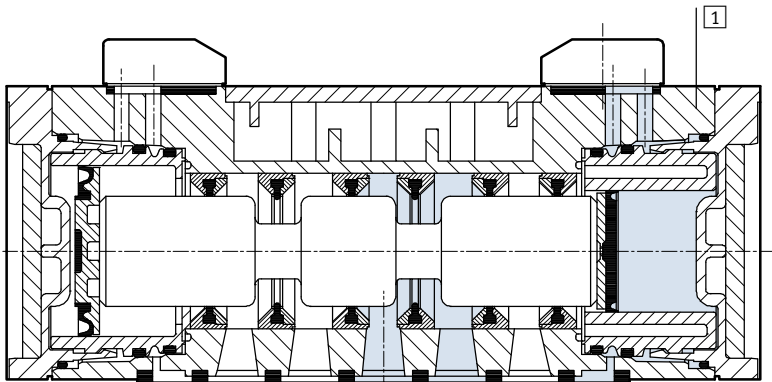

1	Housing	Die-cast aluminium
-	Seals	HNBR, NBR
-	Note on materials	RoHS-compliant

Standard valves to ISO 5599-1, pneumatic valves

Technical data – Width 42 mm

Dimensions

Download CAD data → www.festo.com

5/2-way valves, pneumatic spring reset method, 5/2-way double solenoid valves

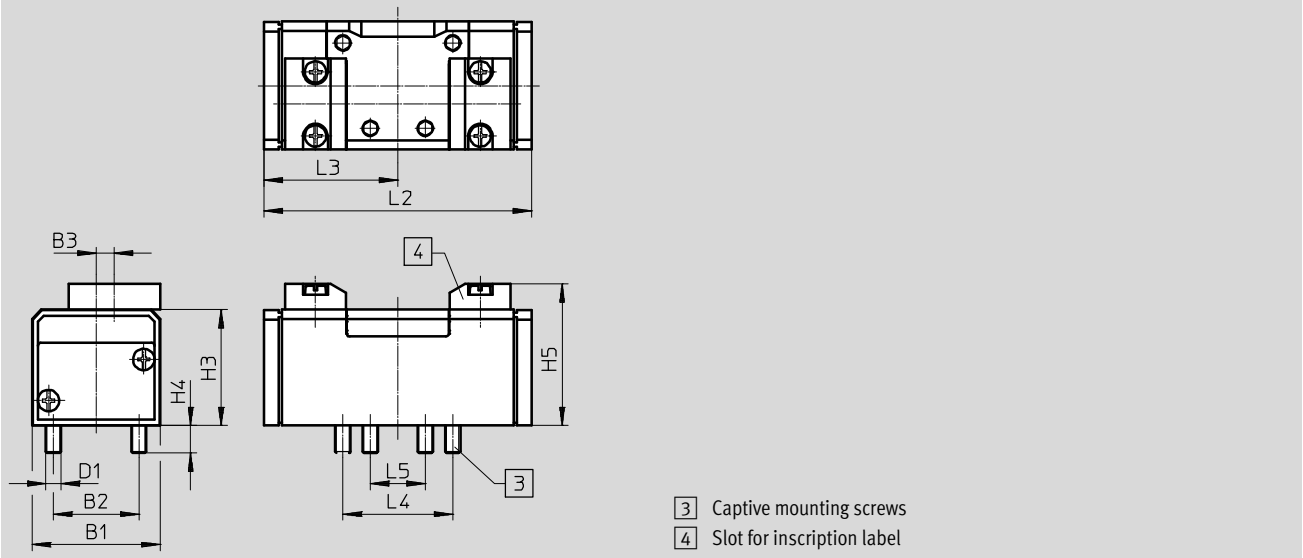

Type	B1	B2	B3	D1	H3	H4	H5	L2	L3	L4	L5
VL-5/2- ...	42	28	6	M5	38	9	46.5	87.6	43.8	36	18
J-5/2- ...											
JD-5/2- ...											

5/2-way valves, mechanical spring reset method

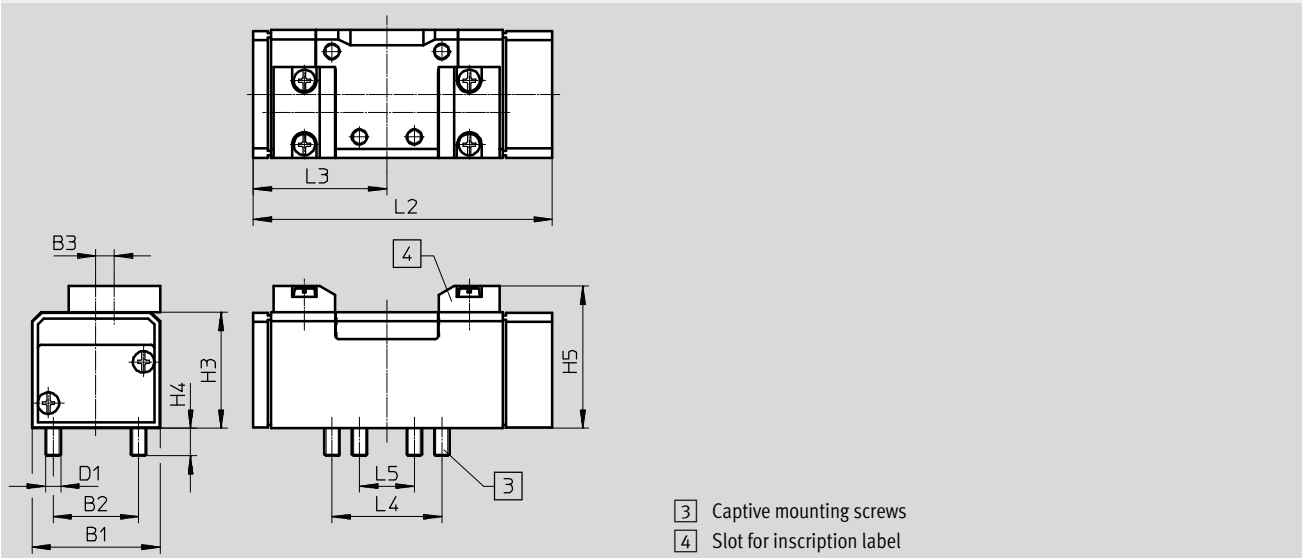

Type	B1	B2	B3	D1	H3	H4	H5	L2	L3	L4	L5
VL-5/2- ... -FR- ...	42	28	6	M5	38	9	46.5	98	43.8	36	18

Standard valves to ISO 5599-1, pneumatic valves

Technical data – Width 42 mm

Dimensions Download CAD data → www.festo.com
 5/3-way valves

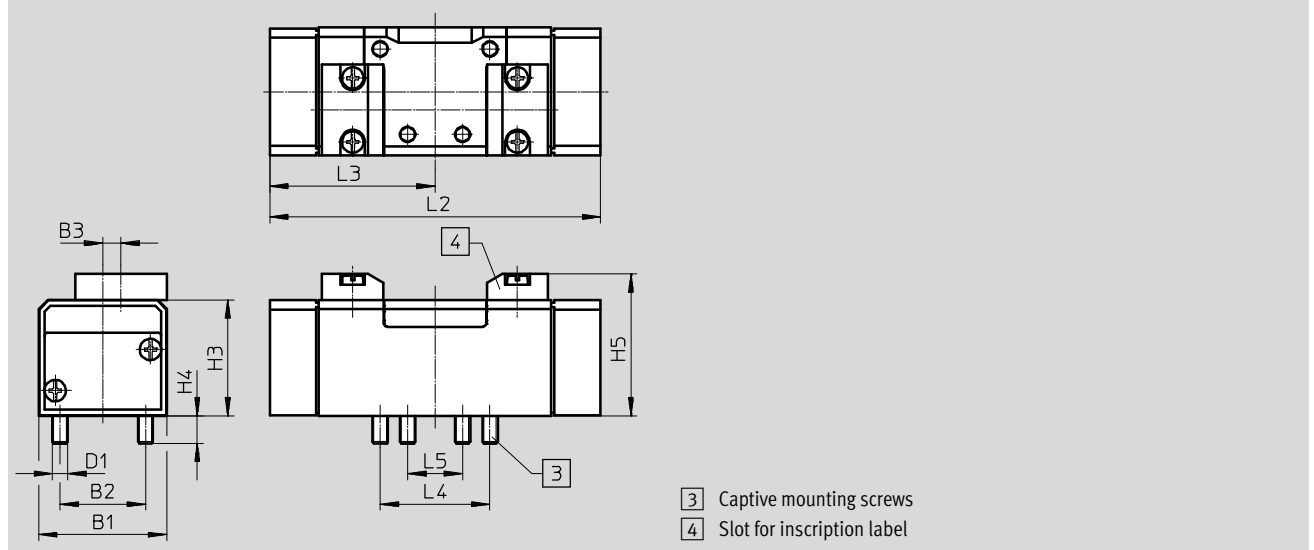

Type	B1	B2	B3	D1	H3	H4	H5	L2	L3	L4	L5
VL-5/3...	42	28	6	M5	38	9	46.5	108.4	54.2	36	18

Standard valves to ISO 5599-1, pneumatic valves

Technical data – Width 42 mm

Ordering data					
Circuit symbol	Description		Weight [g]	Part No.	Type
5/2-way single solenoid valve					
	Pneumatic spring reset method	–	290	151009	VL-5/2-D-1-C
		ATEX category ➔ page 82	290	536007	VL-5/2-D-1-C-EX
	Mechanical spring reset method	–	290	151014	VL-5/2-D-1-FR-C
		ATEX category ➔ page 82	290	536010	VL-5/2-D-1-FR-C-EX
5/2-way double solenoid valve					
	–	–	290	151007	J-5/2-D-1-C
		ATEX category ➔ page 82	290	536013	J-5/2-D-1-C-EX
	With dominant signal at 14	–	290	151008	JD-5/2-D-1-C
		ATEX category ➔ page 82	290	536016	JD-5/2-D-1-C-EX
5/3-way valve					
	Normally closed Mechanical spring reset method	–	320	151010	VL-5/3G-D-1-C
		ATEX category ➔ page 82	320	536019	VL-5/3G-D-1-C-EX
	Normally exhausted Mechanical spring reset method	–	320	151011	VL-5/3E-D-1-C
		ATEX category ➔ page 82	320	536022	VL-5/3E-D-1-C-EX
	Normally pressurised Mechanical spring reset method	–	320	151012	VL-5/3B-D-1-C
		ATEX category ➔ page 82	320	536025	VL-5/3B-D-1-C-EX

Standard valves to ISO 5599-1, pneumatic valves

Technical data – Width 52 mm

Flow rate
2300 l/min



General technical data		
Type	VL- ... -C, J ... -C	VL- ... -EX, J ... -EX
Design	Piston spool valve	Piston spool valve
Sealing principle	Soft	Soft
Actuation type	Pneumatic	Pneumatic
Type of control	Direct	Direct
Direction of flow	Reversible	Reversible
	VL-5/2-D-2-C: non-reversible	VL-5/2-D-2-C-EX: non-reversible
Exhaust function	With flow control	With flow control
Manual override	None	None
Type of mounting	On sub-base, with through-hole and screw	On sub-base, with through-hole and screw
Mounting position	Any	Any
Nominal size [mm]	11.5	11.5
No overlap	Yes	Yes
Width [mm]	52	52
Grid dimension [mm]	56	56
Pneumatic ports	Sub-base size 2 to ISO 5599-1	Sub-base size 2 to ISO 5599-1
Noise level [dB (A)]	85	85
Conforms to standard	ISO 5599-1	ISO 5599-1
Certification	UL Recognised (OL)	–
Maritime classification ¹⁾	See certificate	–

1) Additional information www.festo.com/sp → Certificates.

Flow rates		
Standard nominal flow rate	[l/min]	2300

Switching times [ms]					
		Switching time on	Switching time off	Switching time changeover	Switching time changeover (dominant)
5/2-way single solenoid valve	VL-5/2-D-2-C	23	39	–	–
	VL-5/2-D-2-C-EX	23	39	–	–
	VL-5/2-D-2-FR-C	11	39	–	–
	VL-5/2-D-2-FR-C-EX	11	39	–	–
5/2-way double solenoid valve	J-5/2-D-2-C	–	–	8	–
	J-5/2-D-2-C-EX	–	–	8	–
	JD-5/2-D-2-C	–	–	8	8
	JD-5/2-D-2-C-EX	–	–	8	8
5/3-way valve	VL-5/3G-D-2-C	15	56	–	–
	VL-5/3G-D-2-C-EX	15	56	–	–
	VL-5/3E-D-2-C	16	59	–	–
	VL-5/3E-D-2-C-EX	16	59	–	–
	VL-5/3B-D-2-C	15	57	–	–
	VL-5/3B-D-2-C-EX	15	57	–	–

Standard valves to ISO 5599-1, pneumatic valves

Technical data – Width 52 mm

ATEX	
Type	VL- ... -EX, J ... -EX
ATEX category gas	II 2G
Ignition protection type for gas	c T4
ATEX category for dust	II 2D
Ignition protection type for dust	c T130°C
Explosion-proof ambient temperature [°C]	-10 ≤ Ta ≤ +60
CE marking (see declaration of conformity)	As per EU Explosion Protection Directive (ATEX)

Operating and environmental conditions					
Valve function	5/2-way valve			5/3-way valve	
	Monostable		Bistable		
	Pneumatic spring	Mechanical spring			
Operating medium	Compressed air to ISO 8573-1:2010 [7:4:4]				
Pilot medium	Compressed air to ISO 8573-1:2010 [7:4:4]				
Note on operating/pilot medium	Lubricated operation possible (in which case lubricated operation will always be required)				
Operating pressure [bar]	2 ... 16	-0.9 ... +16	-0.9 ... +16	-0.9 ... +16	
Pilot pressure [bar]	2 ... 16	3 ... 16	2 ... 16	3 ... 16	
Ambient temperature [°C]	-10 ... +60				
Temperature of medium [°C]	-10 ... +60				

Safety characteristics	
Shock resistance	Shock test with severity level 2 to FN 942017-5 and EN 60068-2-27
Vibration resistance	Transport application test with severity level 1 to FN 942017-4 and EN 60068-2-6

Materials

Sectional view

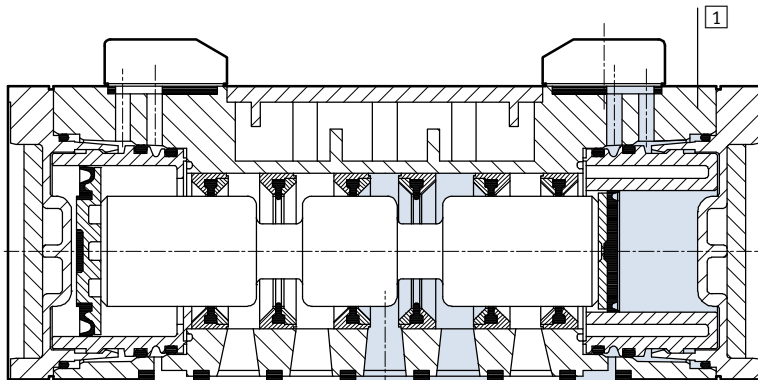

1	Housing	Die-cast aluminium
-	Seals	HNBR, NBR
-	Note on materials	RoHS-compliant

Standard valves to ISO 5599-1, pneumatic valves

Technical data – Width 52 mm

Dimensions

Download CAD data → www.festo.com

5/2-way valves, pneumatic spring reset method, 5/2-way double solenoid valves

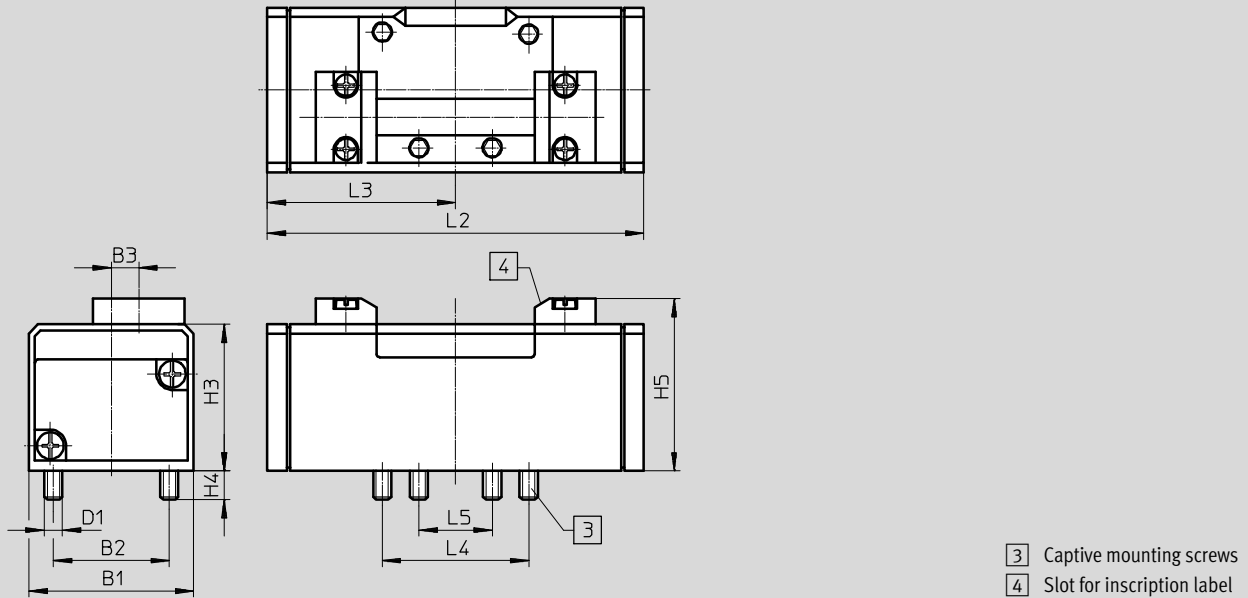

Type	B1	B2	B3	D1	H3	H4	H5	L2	L3	L4	L5
VL-5/2- ...	54	38	9	M6	48	9.5	56.5	123.4	61.7	48	24
J-5/2- ...											
JD-5/2- ...											

5/2-way valves, mechanical spring reset method

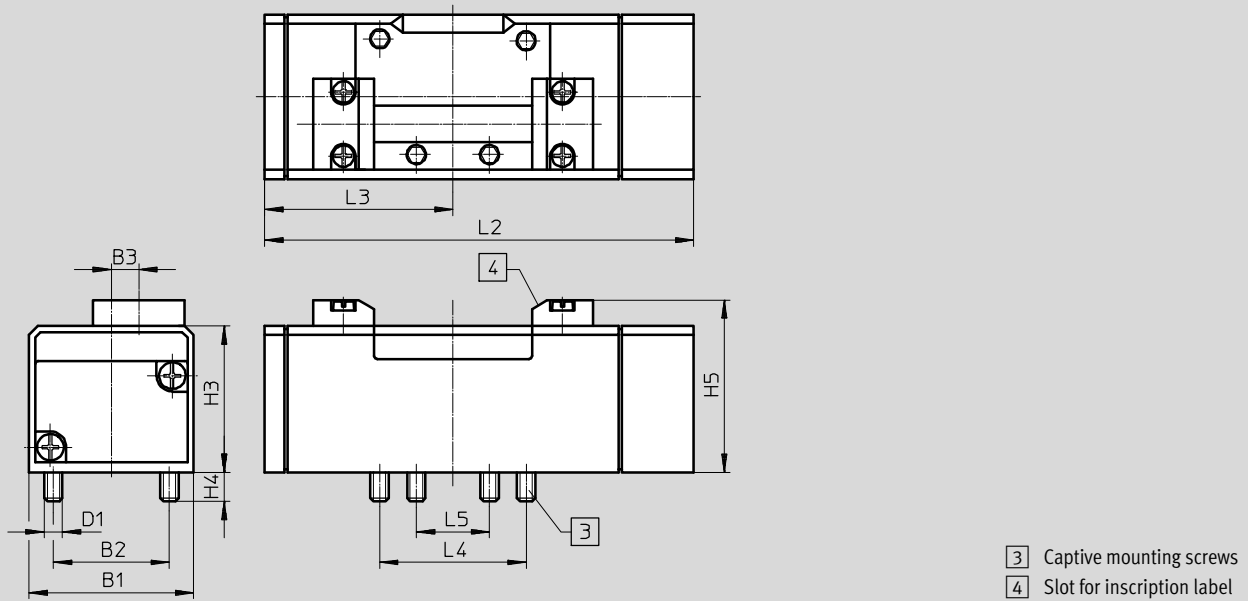

Type	B1	B2	B3	D1	H3	H4	H5	L2	L3	L4	L5
VL-5/2- ... -FR- ...	54	38	9	M6	48	9.5	56.5	140.7	61.7	48	24

Standard valves to ISO 5599-1, pneumatic valves

Technical data – Width 52 mm

Dimensions

Download CAD data → www.festo.com

5/3-way valves

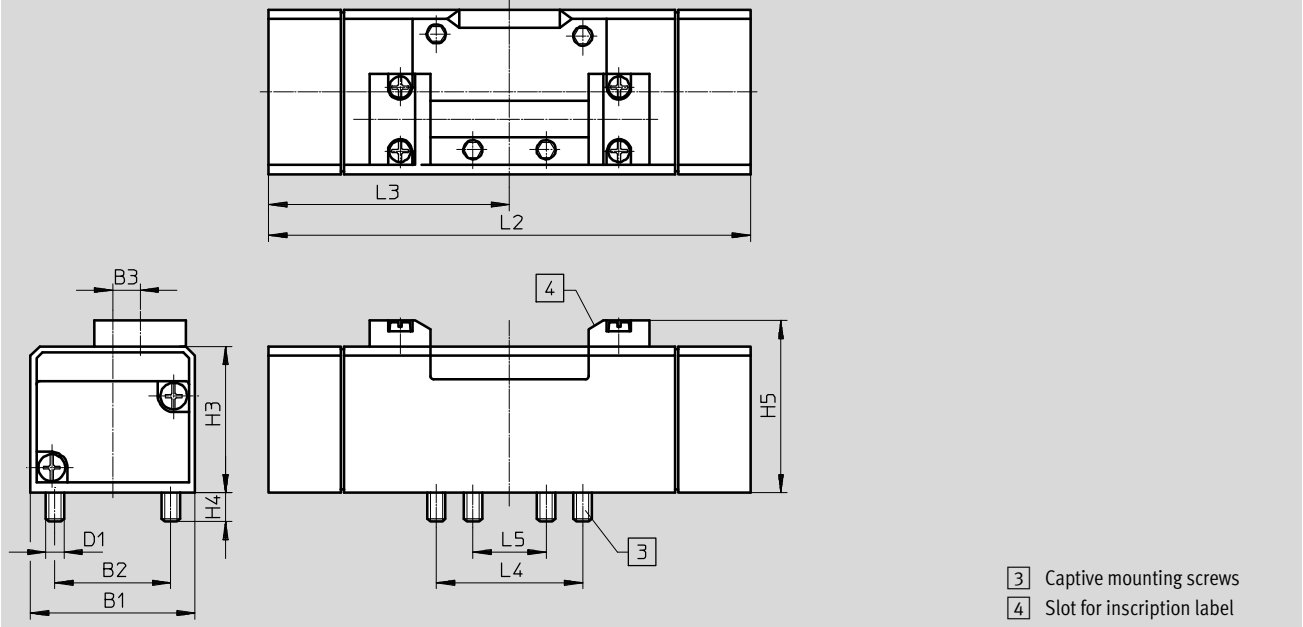

Type	B1	B2	B3	D1	H3	H4	H5	L2	L3	L4	L5
VL-5/3...	54	38	9	M6	48	9.5	56.5	158	79	48	24

Standard valves to ISO 5599-1, pneumatic valves

Technical data – Width 52 mm

Ordering data					
Circuit symbol	Description	Weight [g]	Part No.	Type	
5/2-way single solenoid valve					
	Pneumatic spring reset method	–	550	151845	VL-5/2-D-2-C
		ATEX category → page 87	550	536008	VL-5/2-D-2-C-EX
	Mechanical spring reset method	–	550	151844	VL-5/2-D-2-FR-C
		ATEX category → page 87	550	536011	VL-5/2-D-2-FR-C-EX
5/2-way double solenoid valve					
	–	–	550	151846	J-5/2-D-2-C
		ATEX category → page 87	550	536014	J-5/2-D-2-C-EX
	With dominant signal at 14	–	550	151847	JD-5/2-D-2-C
		ATEX category → page 87	550	536017	JD-5/2-D-2-C-EX
5/3-way valve					
	Normally closed Mechanical spring reset method	–	825	151848	VL-5/3G-D-2-C
		ATEX category → page 87	825	536020	VL-5/3G-D-2-C-EX
	Normally exhausted Mechanical spring reset method	–	825	151849	VL-5/3E-D-2-C
		ATEX category → page 87	825	536023	VL-5/3E-D-2-C-EX
	Normally pressurised Mechanical spring reset method	–	825	151850	VL-5/3B-D-2-C
		ATEX category → page 87	825	536026	VL-5/3B-D-2-C-EX

Standard valves to ISO 5599-1, pneumatic valves

Technical data – Width 65 mm

 Flow rate
 Up to 4600 l/min



General technical data		
Type	VL- ... -C, J ... -C	VL- ... -EX, J ... -EX
Design	Piston spool valve	Piston spool valve
Sealing principle	Soft	Soft
Actuation type	Pneumatic	Pneumatic
Type of control	Direct	Direct
Direction of flow	Reversible	Reversible
	VL-5/2-D-3-C: non-reversible	VL-5/2-D-3-C-EX: non-reversible
Exhaust function	With flow control	With flow control
Manual override	None	None
Type of mounting	On sub-base, with through-hole and screw	On sub-base, with through-hole and screw
Mounting position	Any	Any
Nominal size [mm]	14.5	14.5
No overlap	Yes	Yes
Width [mm]	65	65
Grid dimension [mm]	71	71
Pneumatic ports	Sub-base size 3 to ISO 5599-1	Sub-base size 3 to ISO 5599-1
Noise level [dB (A)]	85	85
Conforms to standard	ISO 5599-1	ISO 5599-1
Certification	UL Recognised (OL)	–
Maritime classification ¹⁾	See certificate	–

1) Additional information www.festo.com/sp → Certificates.

Flow rates				
Valve function	5/2-way valve	5/3-way valve		
		Normally closed	Normally exhausted	Normally pressurised
Standard nominal flow rate [l/min]	4500	4100	4600	4100

Standard valves to ISO 5599-1, pneumatic valves

FESTO

Technical data – Width 65 mm

Switching times [ms]		Switching time on	Switching time off	Switching time changeover	Switching time changeover (dominant)
5/2-way single solenoid valve	VL-5/2-D-1-C	29	36	–	–
	VL-5/2-D-1-C-EX	29	36	–	–
	VL-5/2-D-1-FR-C	13	43	–	–
	VL-5/2-D-1-FR-C-EX	13	43	–	–
5/2-way double solenoid valve	J-5/2-D-1-C	–	–	8	–
	J-5/2-D-1-C-EX	–	–	8	–
	JD-5/2-D-1-C	–	–	8	8
	JD-5/2-D-1-C-EX	–	–	8	8
5/3-way valve	VL-5/3G-D-1-C	17	61	–	–
	VL-5/3G-D-1-C-EX	17	61	–	–
	VL-5/3E-D-1-C	18	63	–	–
	VL-5/3E-D-1-C-EX	18	63	–	–
	VL-5/3B-D-1-C	16	60	–	–
	VL-5/3B-D-1-C-EX	16	60	–	–

ATEX	
Type	VL- ... -EX, J ... -EX
ATEX category gas	II 2G
Ignition protection type for gas	c T4
ATEX category for dust	II 2D
Ignition protection type for dust	c T130°C
Explosion-proof ambient temperature [°C]	–10 ≤ Ta ≤ +60
CE marking (see declaration of conformity)	As per EU Explosion Protection Directive (ATEX)

Operating and environmental conditions					
Valve function	5/2-way valve			5/3-way valve	
	Monostable		Bistable		
	Pneumatic spring	Mechanical spring			
Operating medium	Compressed air to ISO 8573-1:2010 [7:4:4]				
Pilot medium	Compressed air to ISO 8573-1:2010 [7:4:4]				
Note on operating/pilot medium	Lubricated operation possible (in which case lubricated operation will always be required)				
Operating pressure [bar]	2 ... 16	–0.9 ... +16	–0.9 ... +16	–0.9 ... +16	
Pilot pressure [bar]	2 ... 16	3 ... 16	2 ... 16	3 ... 16	
Ambient temperature [°C]	–10 ... +60				
Temperature of medium [°C]	–10 ... +60				

Safety characteristics	
Shock resistance	Shock test with severity level 2 to FN 942017-5 and EN 60068-2-27
Vibration resistance	Transport application test with severity level 1 to FN 942017-4 and EN 60068-2-6

Standard valves to ISO 5599-1, pneumatic valves

Technical data – Width 65 mm

Materials

Sectional view

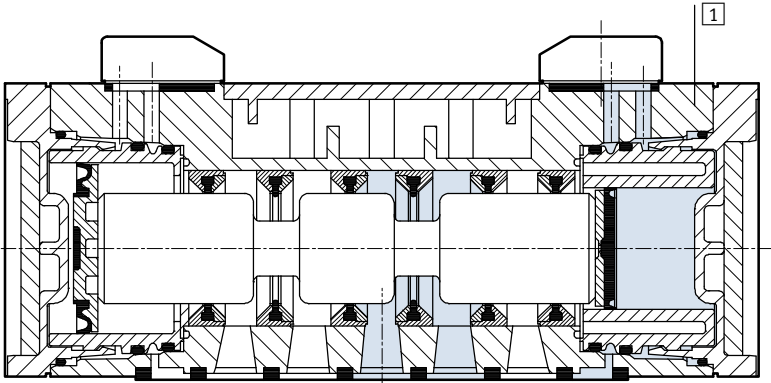

1	Housing	Die-cast aluminium
-	Seals	HNBR, NBR
-	Note on materials	RoHS-compliant

Dimensions

Download CAD data → www.festo.com

5/2-way valves, pneumatic spring reset method, 5/2-way double solenoid valves

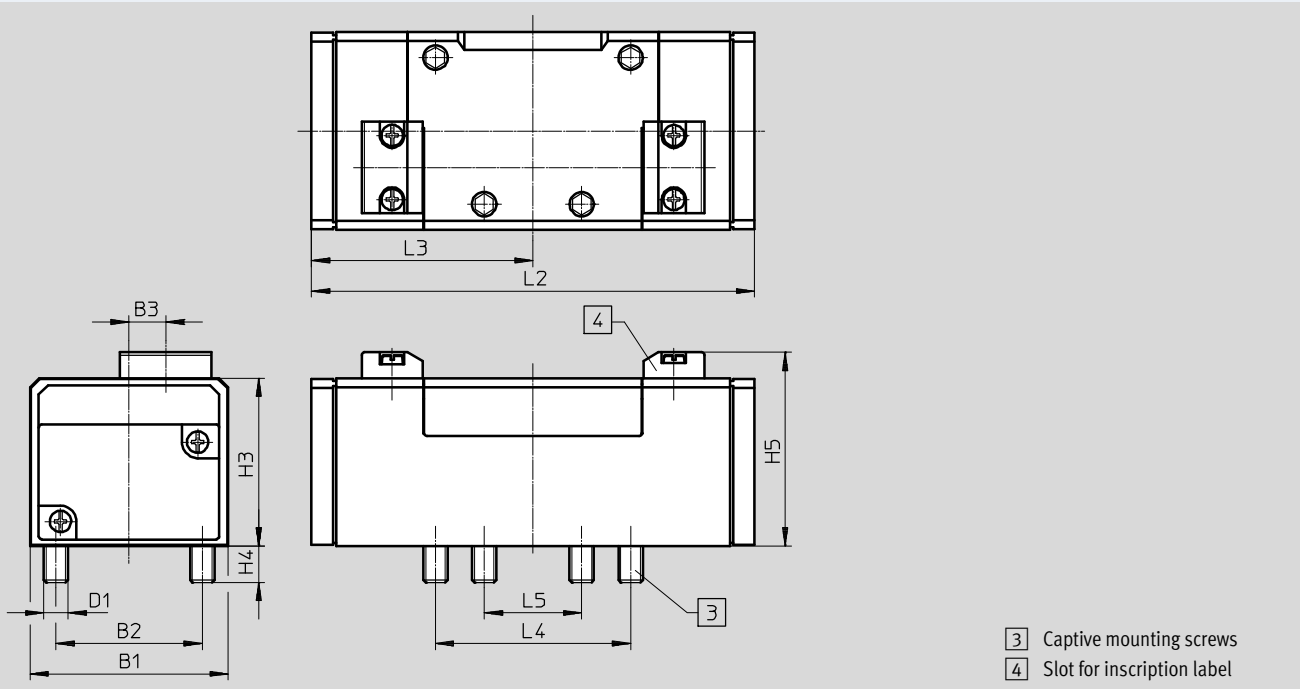

Type	B1	B2	B3	D1	H3	H4	H5	L2	L3	L4	L5
VL-5/2- ...	65	48	12	M8	55	12	63.5	145.4	72.7	64	32
J-5/2- ...											
JD-5/2- ...											

Standard valves to ISO 5599-1, pneumatic valves

Technical data – Width 65 mm

Dimensions

Download CAD data → www.festo.com

5/2-way valves, mechanical spring reset method

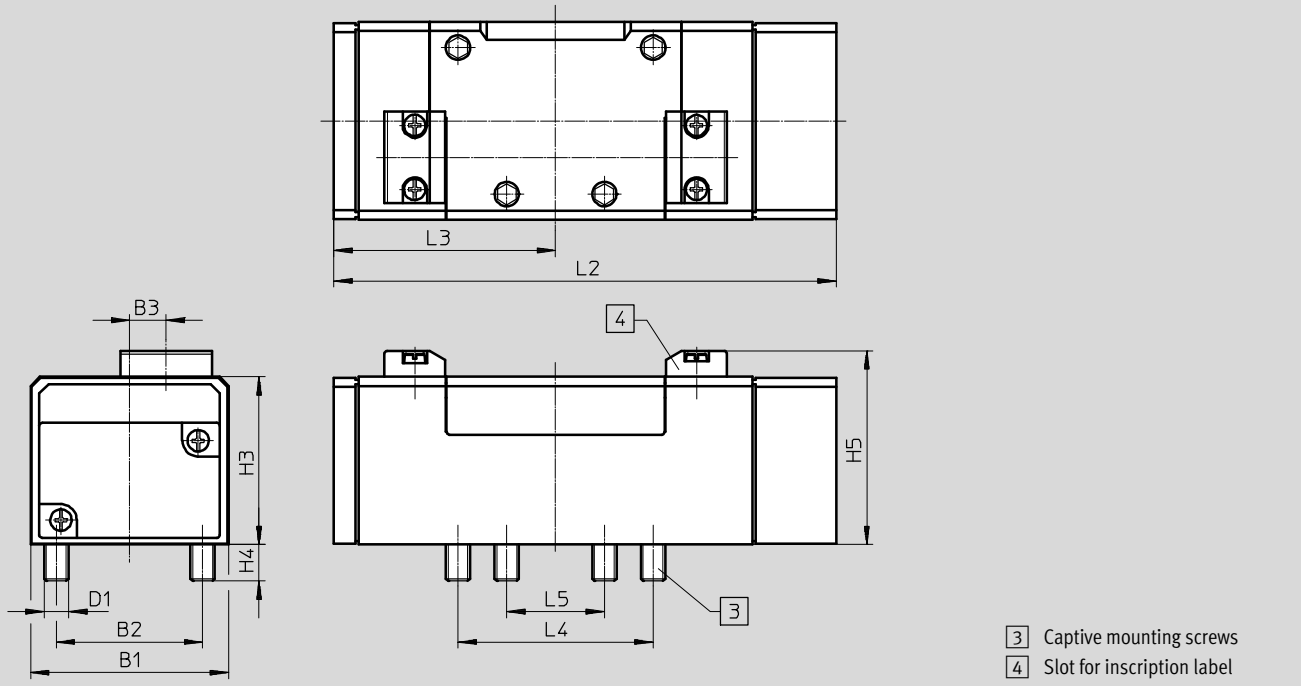

Type	B1	B2	B3	D1	H3	H4	H5	L2	L3	L4	L5
VL-5/2- ... -FR- ...	65	48	12	M8	55	12	63.5	164.7	72.7	64	32

5/3-way valves

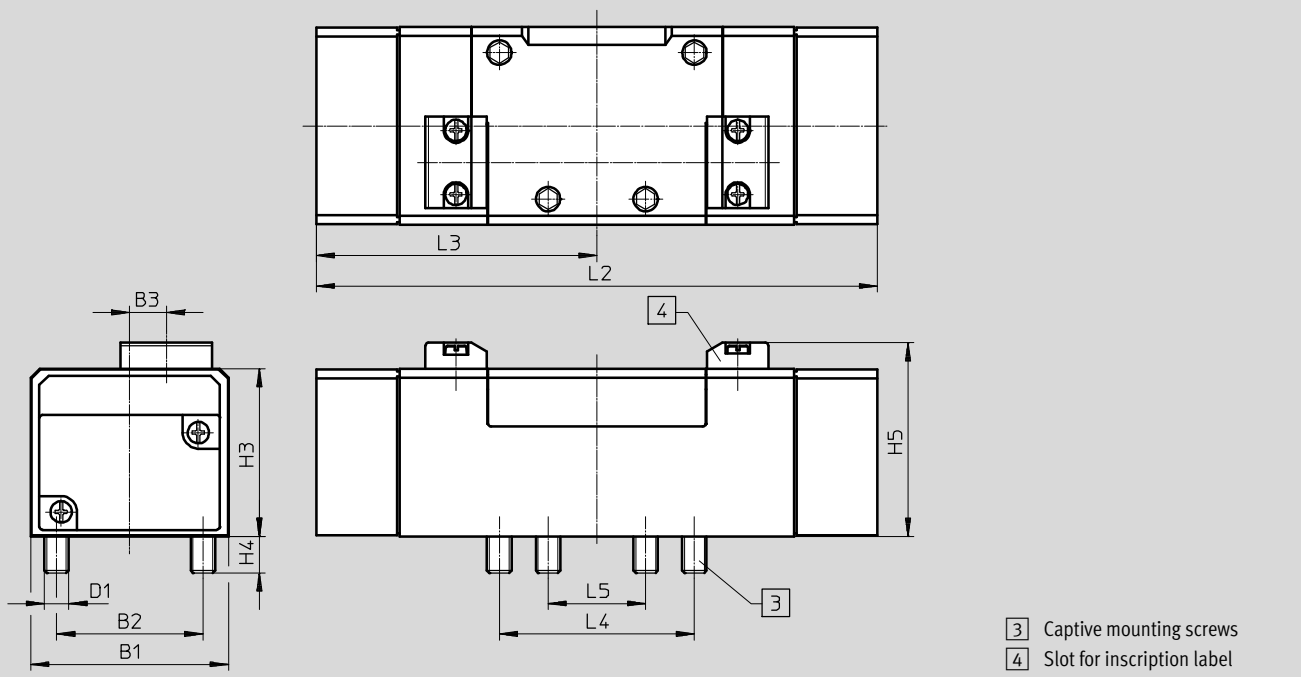

Type	B1	B2	B3	D1	H3	H4	H5	L2	L3	L4	L5
VL-5/3...	65	48	12	M8	55	12	63.5	184	92	64	32

Standard valves to ISO 5599-1, pneumatic valves

Technical data – Width 65 mm

Ordering data					
Circuit symbol	Description		Weight [g]	Part No.	Type
5/2-way single solenoid valve					
	Pneumatic spring reset method	–	810	151864	VL-5/2-D-3-C
		ATEX category → page 92	810	536009	VL-5/2-D-3-C-EX
	Mechanical spring reset method	–	810	151863	VL-5/2-D-3-FR-C
		ATEX category → page 92	810	536012	VL-5/2-D-3-FR-C-EX
5/2-way double solenoid valve					
	–	–	810	151865	J-5/2-D-3-C
		ATEX category → page 92	810	536015	J-5/2-D-3-C-EX
	With dominant signal at 14	–	810	151866	JD-5/2-D-3-C
		ATEX category → page 92	810	536018	JD-5/2-D-3-C-EX
5/3-way valve					
	Normally closed Mechanical spring reset method	–	910	151867	VL-5/3G-D-3-C
		ATEX category → page 92	910	536021	VL-5/3G-D-3-C-EX
	Normally exhausted Mechanical spring reset method	–	910	151868	VL-5/3E-D-3-C
		ATEX category → page 92	910	536024	VL-5/3E-D-3-C-EX
	Normally pressurised Mechanical spring reset method	–	910	151869	VL-5/3B-D-3-C
		ATEX category → page 92	910	536027	VL-5/3B-D-3-C-EX

Standard valves to ISO 5599-1, pneumatic valves

Technical data – Width 76 mm

-  - Flow rate
Up to 6000 l/min



General technical data	
Design	Piston spool valve
Sealing principle	Soft
Actuation type	Pneumatic
Type of control	Direct
Direction of flow	Reversible
Exhaust function	With flow control
Manual override	None
Type of mounting	On sub-base, with through-hole and screw
Mounting position	Any
Nominal size [mm]	18
No overlap	Yes
Width [mm]	76
Grid dimension [mm]	82
Pneumatic ports	Sub-base size 4 to ISO 5599-1
Noise level [dB (A)]	85
Conforms to standard	ISO 5599-1

Flow rates			
Valve function		5/2-way valve	5/3-way valve
Standard nominal flow rate [l/min]		6000	4800

Switching times [ms]				
		Switching time on	Switching time off	Switching time changeover
5/2-way single solenoid valve	VL-5/2-3/4-D-4	25	90	–
5/2-way double solenoid valve	J-5/2-3/4-D-4	–	–	20
5/3-way valve	VL-5/3G-3/4-D-4	40	130	–
	VL-5/3E-3/4-D-4	50	170	–

Standard valves to ISO 5599-1, pneumatic valves

Technical data – Width 76 mm

Operating and environmental conditions				
Valve function	5/2-way valve			5/3-way valve
	Monostable	Bistable		
Operating medium	Compressed air to ISO 8573-1:2010 [7:4:4]			
Pilot medium	Compressed air to ISO 8573-1:2010 [7:4:4]			
Note on operating/pilot medium	Lubricated operation possible (in which case lubricated operation will always be required)			
Operating pressure	[bar]	-0.9 ... +16	-0.9 ... +16	-0.9 ... +16
Pilot pressure	[bar]	3 ... 16	2 ... 16	3 ... 16
Ambient temperature	[°C]	-10 ... +60		
Temperature of medium	[°C]	-10 ... +60		

Materials

Sectional view

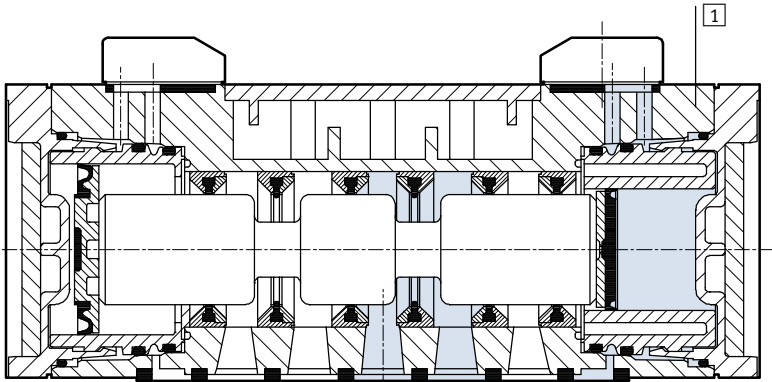

1	Housing	Aluminium
-	Seals	NBR
-	Note on materials	RoHS-compliant

Standard valves to ISO 5599-1, pneumatic valves

Technical data – Width 76 mm

Dimensions

Download CAD data → www.festo.com

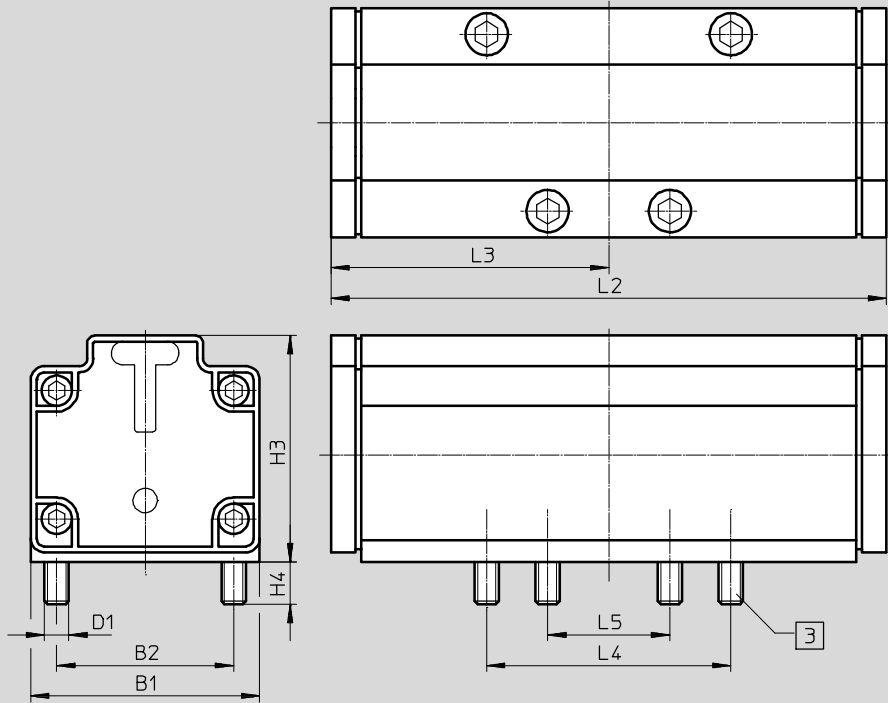

3 Captive mounting screws

Type	B1	B2	D1	H3	H4	L2	L3	L4	L5
VL-5/2-3/4-D-4	76	58	M8	74	14	182	91	80	40
J-5/2-3/4-D-4									
VL-5/3E-3/4-D-4									
VL-5/3G-3/4-D-4									

Standard valves to ISO 5599-1, pneumatic valves

Technical data – Width 76 mm

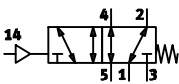
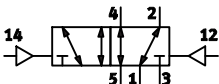
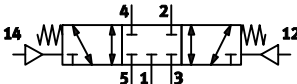
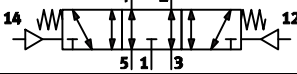
Ordering data				
Circuit symbol	Description	Weight [g]	Part No.	Type
5/2-way single solenoid valve				
	Mechanical spring reset method	1800	12461	VL-5/2-3/4-D-4
5/2-way double solenoid valve				
	–	1800	12462	J-5/2-3/4-D-4
5/3-way valve				
	Normally closed Mechanical spring reset method	2000	12463	VL-5/3G-3/4-D-4
	Normally exhausted Mechanical spring reset method	2000	12464	VL-5/3E-3/4-D-4

Standard valves to ISO 5599-1, individual sub-base



Accessories

Individual sub-base NAS

Ports at side

Materials:

Width 42 mm, 52 mm, 65 mm:

Die-cast aluminium

Width 76 mm:

Anodised aluminium



General technical data	
Conforms to standard	ISO 5599-1
Type of mounting	2 through-holes in housing

Operating and environmental conditions				
Width	42 mm	52 mm	65 mm	76 mm
Note on materials	Free of copper and PTFE			-
Certification	UL Recognised (OL)			-

Dimensions

Download CAD data → www.festo.com

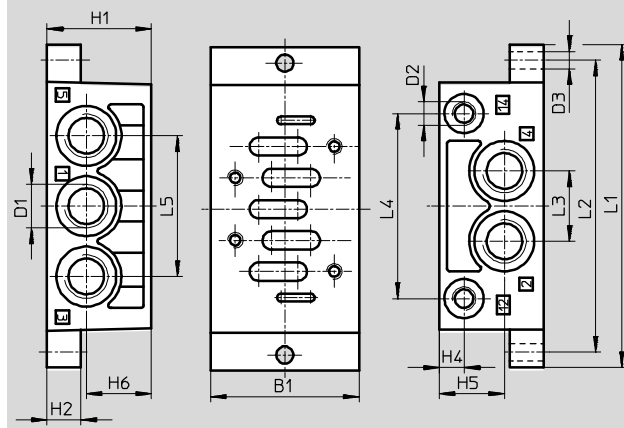

Width	B1	D1	D2	D3	H1	H2	H4	H5	H6	L1	L2	L3	L4	L5
42 mm	48	G1/4	G1/8	5.5	32	10	9	20.3	20.3	110	98	23	60	46
52 mm	57	G3/8	G1/8	6.6	40	13	9	25	25	124	112	27	71	54
65 mm	71	G1/2	G1/8	6.6	32	18	9	16	16	149	136	32	91	64
76 mm	85	G3/4	G1/8	9	42	19	9	21	21	186	170	42	111	84

Ordering data						
Designation to VDMA	Width	Pneumatic port		Weight [g]	Part No.	Type
		1, 2, 3, 4, 5	12, 14			
VDMA 24345-A-1	42 mm	G1/4	G1/8	190	★ 9484	NAS-1/4-1A-ISO
VDMA 24345-A-2	52 mm	G3/8	G1/8	300	11310	NAS-3/8-2A-ISO
VDMA 24345-A-3	65 mm	G1/2	G1/8	360	10336	NAS-1/2-3A-ISO
VDMA 24345-A-4	76 mm	G3/4	G1/8	1260	152813	NAS-3/4-4A-ISO

• Note: This product conforms to ISO 1179-1 and to ISO 228-1

Festo core product range

- ★ Ready for dispatch from the Festo factory in 24 hours
- ☆ Ready for dispatch in 5 days maximum from stock

Standard valves to ISO 5599-1, individual sub-base

Accessories

Individual sub-base NAU

Ports underneath

Materials:

Width 42 mm, 52 mm, 65 mm:
Die-cast aluminium

Width 76 mm:
Anodised aluminium

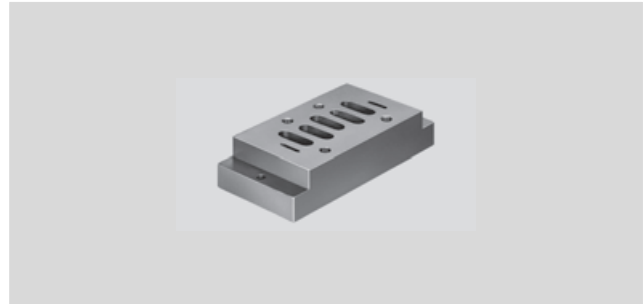

General technical data	
Conforms to standard	ISO 5599-1
Type of mounting	2 through-holes in housing

Operating and environmental conditions				
Width	42 mm	52 mm	65 mm	76 mm
Note on materials	Free of copper and PTFE			–
Certification	UL Recognised (OL)		–	–

Dimensions Download CAD data → www.festo.com

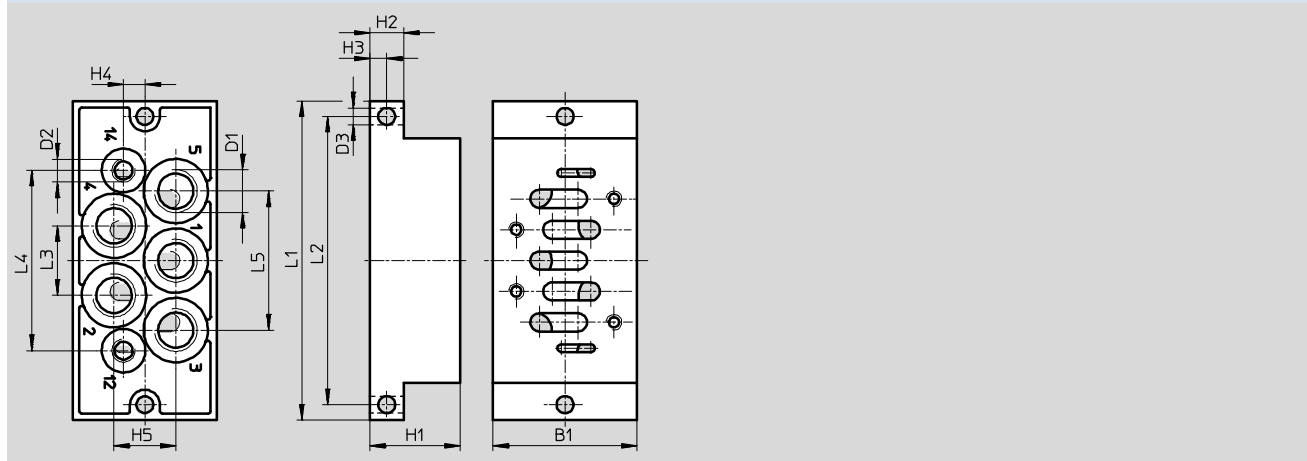

Width	B1	D1	D2	D3	H1	H2	H3	H4	H5	L1	L2	L3	L4	L5
42 mm	46	G1/4	G1/8	5.5	30	10	5	7.5	20	110	98	23	60.7	46
52 mm	56	G3/8	G1/8	6.6	35	13	6.5	8.3	24	124	112	27	70	54
65 mm	71	G1/2	G1/8	6.6	32	18	9	10	30	149	136	33	90	66
76 mm	85	G3/4	G1/8	9	28	19	9.5	12	37	186	170	42	111	84

Ordering data						
Designation to VDMA	Width	Pneumatic port		Weight [g]	Part No.	Type
		1, 2, 3, 4, 5	12, 14			
VDMA 24345-B-1	42 mm	G1/4	G1/8	280	★ 9485	NAU-1/4-1B-ISO
VDMA 24345-B-2	52 mm	G3/8	G1/8	450	11416	NAU-3/8-2B-ISO
VDMA 24345-B-3	65 mm	G1/2	G1/8	660	10337	NAU-1/2-3B-ISO
VDMA 24345-B-4	76 mm	G3/4	G1/8	1080	152814	NAU-3/4-4B-ISO

– | – Note: This product conforms to ISO 1179-1 and to ISO 228-1

Festo core product range

- ★ Ready for dispatch from the Festo factory in 24 hours
- ☆ Ready for dispatch in 5 days maximum from stock

Standard valves to ISO 5599-1, manifold components

Accessories

Manifold sub-base NAV

Ports underneath

Materials:

Width 42 mm, 52 mm, 65 mm:

Die-cast aluminium

Width 76 mm:

Anodised aluminium

Dimensions → page 105



General technical data	
Conforms to standard	ISO 5599-1

Operating and environmental conditions				
Width	42 mm	52 mm	65 mm	76 mm
Certification	–	UL Recognised (OL)	–	–

Ordering data						
Designation to VDMA	Width	Pneumatic port		Weight [g]	Part No.	Type
		2, 4	12, 14			
VDMA 24345-C-1	42 mm	G1/4	G1/8	240	★ 10173	NAV-1/4-1C-ISO
VDMA 24345-C-2	52 mm	G3/8	G1/8	400	11305	NAV-3/8-2C-ISO
VDMA 24345-C-3	65 mm	G1/2	G1/8	700	10175	NAV-1/2-3C-ISO
VDMA 24345-C-4	76 mm	G3/4	G1/8	1400	11139	NAV-3/4-4C-ISO

90° connection plate NAW

Ports at side and top

Materials:

Width 42 mm, 52 mm, 65 mm:

Die-cast aluminium

Width 76 mm:

Anodised aluminium

Dimensions → page 105

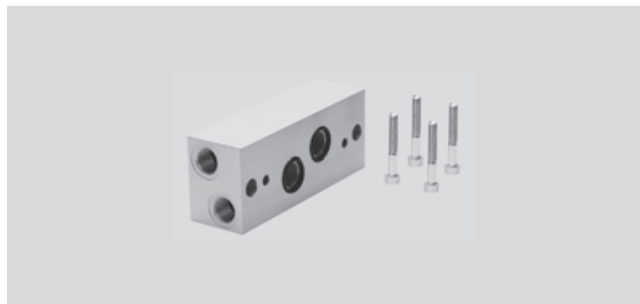

General technical data	
Conforms to standard	ISO 5599-1

Operating and environmental conditions				
Width	42 mm	52 mm	65 mm	76 mm
Note on materials	Free of copper and PTFE	–	–	–

Ordering data						
Designation to VDMA	Width	Pneumatic port		Weight [g]	Part No.	Type
		2, 4	12, 14			
VDMA 24345-E-1	42 mm	G1/4	G1/8	360	11304	NAW-1/4-1E-ISO
VDMA 24345-E-2	52 mm	G3/8	G1/8	600	11307	NAW-3/8-2E-ISO
VDMA 24345-E-3	65 mm	G1/2	G1/8	920	11309	NAW-1/2-3E-ISO
VDMA 24345-E-4	76 mm	G3/4	G1/8	1550	11141	NAW-3/4-4E-ISO

• Note: This product conforms to ISO 1179-1 and to ISO 228-1

Festo core product range	★ Ready for dispatch from the Festo factory in 24 hours
	☆ Ready for dispatch in 5 days maximum from stock

Standard valves to ISO 5599-1, manifold components

Accessories

Manifold sub-base with 90° connections NAVW

Ports at side and underneath

Materials:

Die-cast aluminium

Dimensions → page 105



General technical data	
Conforms to standard	ISO 5599-1

Operating and environmental conditions	
Operating medium	Compressed air to ISO 8573-1:2010 [7:-:-]

Ordering data					
Width	Pneumatic port		Weight [g]	Part No.	Type
	2, 4	12, 14			
42 mm	G1/4	G1/8	320	152789	NAVW-1/4-1-ISO
52 mm	G3/8	G1/8	550	152790	NAVW-3/8-2-ISO
65 mm	G1/2	G1/8	1020	152791	NAVW-1/2-3-ISO

End plate kit NEV

Materials:

Width 42 mm, 52 mm, 65 mm:

Die-cast aluminium

Width 76 mm:

Anodised aluminium

Dimensions → page 105



General technical data	
Conforms to standard	ISO 5599-1

Operating and environmental conditions				
Width	42 mm	52 mm	65 mm	76 mm
Note on materials	Free of copper and PTFE			-

Ordering data					
Designation to VDMA	Width	Pneumatic port	Weight [g]	Part No.	Type
		1, 3, 5			
VDMA 24345-D-1	42 mm	G3/8	280	★ 10174	NEV-1DA/DB-ISO
VDMA 24345-D-2	52 mm	G1/2	450	11306	NEV-2DA/DB-ISO
VDMA 24345-D-3	65 mm	G1	760	10176	NEV-3DA/DB-ISO
VDMA 24345-D-4	76 mm	G1	1390	11140	NEV-4DA/DB-ISO

- | - Note: This product conforms to ISO 1179-1 and to ISO 228-1

Festo core product range

- ★ Ready for dispatch from the Festo factory in 24 hours
- ☆ Ready for dispatch in 5 days maximum from stock

Standard valves to ISO 5599-1, manifold components

Accessories

Blanking plate NDV

Materials:
 Width 42 mm, 52 mm, 65 mm:
 Steel

 Width 76 mm:
 Wrought aluminium alloy

 Dimensions → page 105



General technical data	
Conforms to standard	ISO 5599-1

Operating and environmental conditions	
Operating medium	Compressed air to ISO 8573-1:2010 [7:-:-]
Note on operating/pilot medium	Lubricated operation possible (in which case lubricated operation will always be required)

Ordering data			
Width	Weight [g]	Part No.	Type
42 mm	113	★ 9489	NDV-1-ISO
52 mm	166	11308	NDV-2-ISO
65 mm	314	10340	NDV-3-ISO
76 mm	1480	11142	NDV-4-ISO

Isolating disc NSC

Materials:
 Die-cast aluminium

 Dimensions → page 105



General technical data	
Conforms to standard	ISO 5599-1

Operating and environmental conditions				
Width	42 mm	52 mm	65 mm	76 mm
Note on materials	Free of copper and PTFE			-

Ordering data				
Width	Pneumatic port	Weight [g]	Part No.	Type
42 mm	G1/4	6	★ 11550	NSC-1/4-1-ISO
52 mm	G3/8	9.2	11908	NSC-3/8-2-ISO
65 mm	G1/2	20	11551	NSC-1/2-3-ISO
76 mm	G3/4	24	11699	NSC-3/4-4-ISO

Festo core product range
 ★ Ready for dispatch from the Festo factory in 24 hours
 ☆ Ready for dispatch in 5 days maximum from stock

Standard valves to ISO 5599-1, manifold components

Accessories

Dimensions – Manifold assembly

Download CAD data → www.festo.com

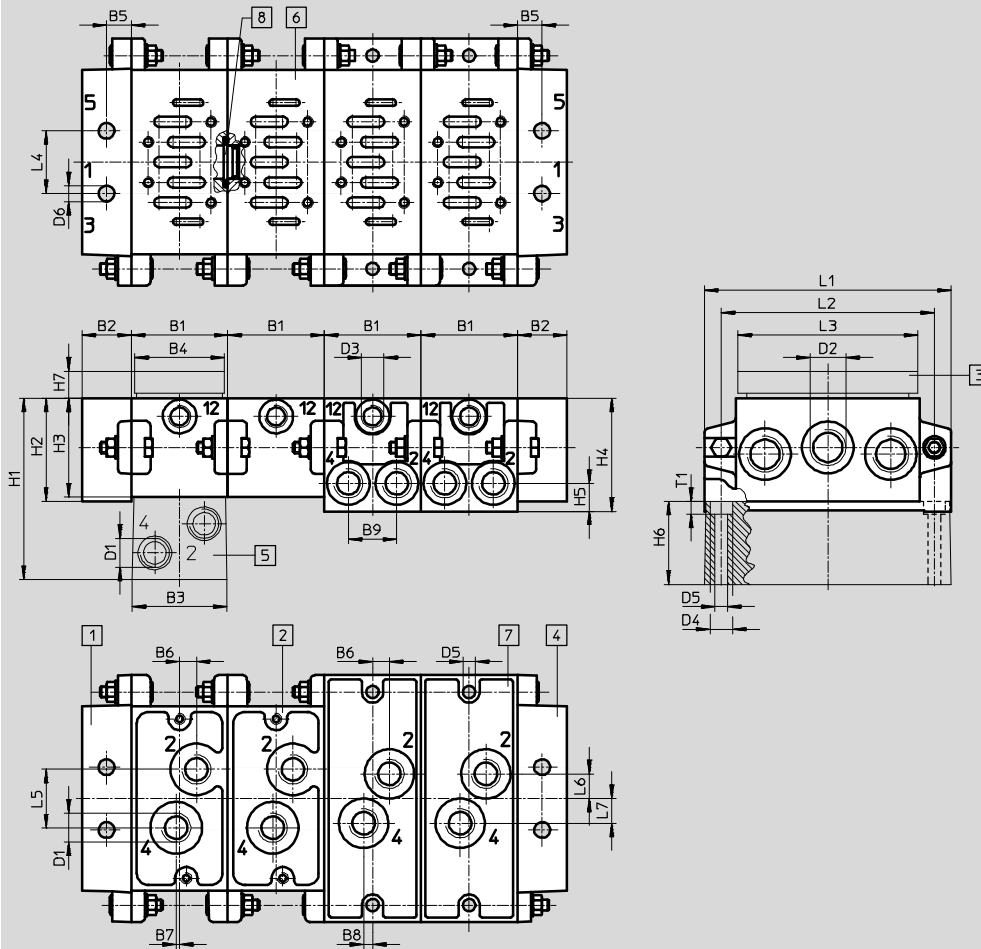

- 1 Left-hand end plate, end plate kit NEV
- 2 Manifold sub-base NAV
- 3 Blanking plate NDV
- 4 Right-hand end plate, end plate kit NEV
- 5 90° connection plate NAW
- 6 Port pattern to ISO 5599-1
- 7 Manifold sub-base with 90° connections NAVW
- 8 Isolating disc NSC

Width	B1	B2	B3	B4	B5	B6	B7	B8	B9	D1	D2	D3	D4	D5	D6
42 mm	43	22	42	40	11	7.5	1.5	4	21.6	G1/4	G3/8	G1/8	10	5.5	7
52 mm	56	26	55	50	13	6	5	6	27	G3/8	G1/2	G1/8	11	6.6	9
65 mm	71	30	70	70	15	8	6	6	35.5	G1/2	G1	G1/8	15	9	12
76 mm	82	30	80	80	15	9	8	-	-	G3/4	G1	G1/8	15	9	12

Width	H1	H2	H3	H4	H5	H6	H7	L1	L2	L3	L4	L5	L6	L7	T1
42 mm	81	46	44	50.5	12.5	37	5	110	95	80	28	26	11	11	5.7
52 mm	85	47	45	60	15	40	5	135	115	96	35	30	15	14	6.8
65 mm	99	56	54	66	17.5	45	5	190	168	120	52	38	19	19	9
76 mm	120	58	55	-	-	65	5	215	184	-	56	52	-	-	9

Note: This product conforms to ISO 1179-1 and to ISO 228-1

Standard valves to ISO 5599-1, manifold components



Accessories

Intermediate plate NZV

For connecting manifold sub-bases of different sizes

Materials:
Die-cast aluminium, anodised

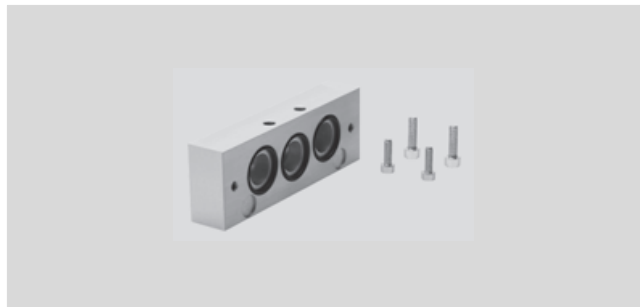

General technical data	
Based on standard	ISO 5599-1
Note on materials	Free of copper and PTFE

Dimensions Download CAD data → www.festo.com

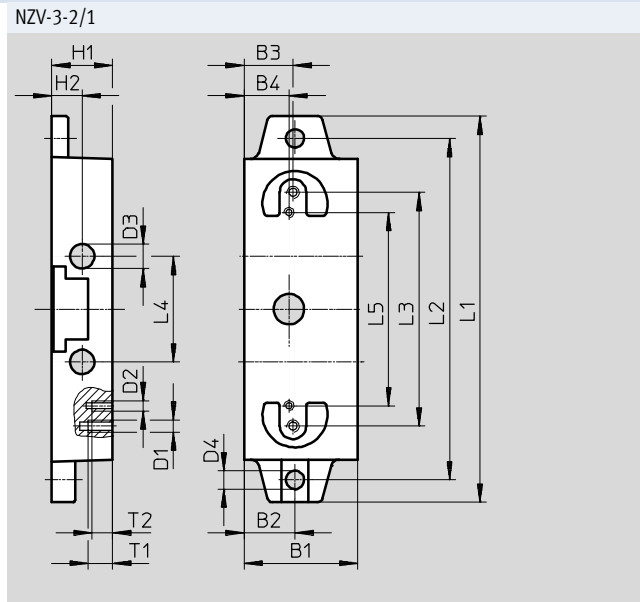
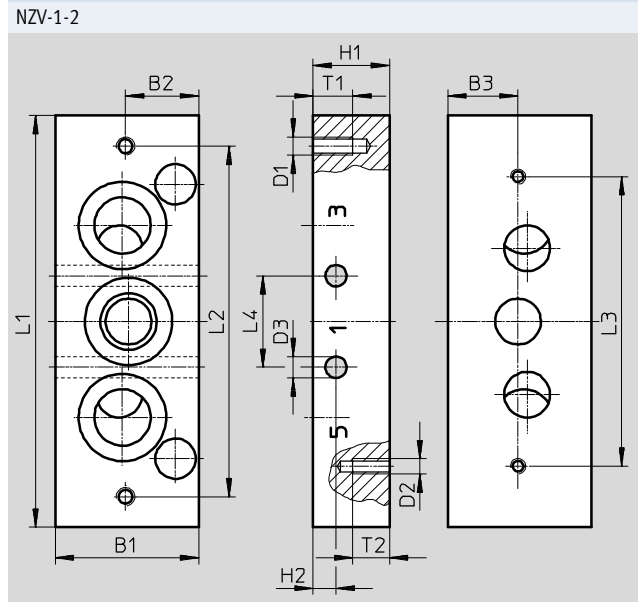

Type	B1	B2	B3	B4	D1	D2	D3	D4	H1	H2	L1	L2	L3	L4	L5	T1	T2
NZV-1-2	47	24	23	-	M6	M5	7	-	25	7.5	135	115	95	30	-	13	12
NZV-3-2/1	56	25	24	22	M6	M5	12	9	30	15	190	168	115	52	95	12	10

Ordering data		Weight [g]	Part No.	Type
For manifold sub-bases of width 42 mm, 52 mm		393	164940	NZV-1-2
For manifold sub-bases of width 42 mm and 65 mm or 52 mm and 65 mm		473	12911	NZV-3-2/1

Standard valves to ISO 5599-1, flow control plate

Accessories

Function

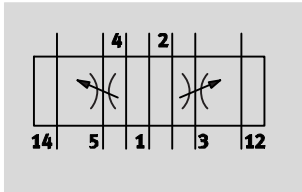

Exhaust air flow control valve for 3 and 5.



General technical data			
Type	VABF-S1-1-F1B1-C	VABF-S1-2-F1B1-C	GRO-ZP-3-ISO
Based on standard	ISO 5599-1		
Pneumatic vertical stacking	Flow control plate, exhaust air flow control		
Mounting position	Any		
Type of mounting	Via through-hole		
Standard nominal flow rate [l/min]	1100	–	1500
Degree of protection	IP65	IP65	–
	NEMA4	NEMA4	–

Materials	
Housing	Die-cast aluminium
Note on materials	RoHS-compliant

Operating and environmental conditions			
Type	VABF-S1-1-F1B1-C	VABF-S1-2-F1B1-C	GRO-ZP-3-ISO
Operating medium	Compressed air to ISO 8573-1:2010 [7:4:4]		Compressed air to ISO 8573-1:2010 [7:--:--]
Note on operating/pilot medium	Lubricated operation possible (in which case lubricated operation will always be required)		Lubricated operation possible (in which case lubricated operation will always be required)
Operating pressure [bar]	–0.9 ... +10	–0.9 ... +10	0 ... +16
Supply pressure 1 [bar]	–	+0.5 ... +10	–
Ambient temperature [°C]	–5 ... +50	–5 ... +50	–20 ... +80
Temperature of medium [°C]	–	–	–20 ... +80

Standard valves to ISO 5599-1, flow control plate

Accessories

Standard nominal flow rate q_{pN} as a function of the turns n of the regulating screw

VABF-S1-1-F1B1-C

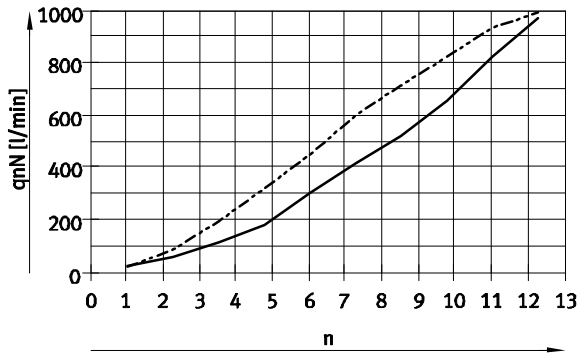

— Flow control screw from 2 → 3
 - - - Flow control screw from 4 → 5

VABF-S1-2-F1B1-C

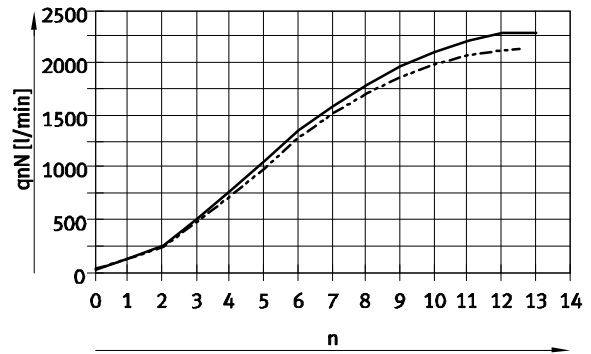

— Flow control screw from 2 → 3
 - - - Flow control screw from 4 → 5

GRO-ZP-3-ISO

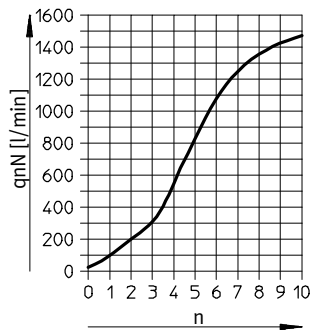

Standard valves to ISO 5599-1, flow control plate

Accessories

Dimensions Download CAD data → www.festo.com

VABF-S1-...

1 Captive mounting screws
2 Port pattern to ISO 5599-1

GRO-ZP-3-ISO

1 Regulating screw for flow control valve
2 Captive mounting screws

Type	Width	B1	B2	B3	D1	H1	H2	H3	H4	L1	L2	L3	L5	L6	T1
VABF-S1-1-F1B1-C	42 mm	39.9	24.3	16.1	9.3	17.5	9.2	–	28	105.3	–	–	–	32	7.3
VABF-S1-2-F1B1-C	52 mm	52	32.5	22.5	13.4	29.5	13.5	–	45	131	–	–	–	40.9	10
GRO-ZP-3-ISO	65 mm	70	48	–	M8	33	12	16.5	–	132	64	32	7	–	–

Ordering data		Description	Width	Weight [g]	Part No.	Type
	Exhaust air flow control valve	42 mm	220	549102	VABF-S1-1-F1B1-C	
		52 mm	565	555788	VABF-S1-2-F1B1-C	
		65 mm	850	119674	GRO-ZP-3-ISO	

Standard valves to ISO 5599-1, vertical supply plate

Accessories

Function

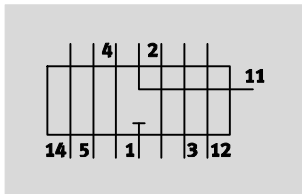

Alternative compressed air supply for port 1 of the assembled valve.



General technical data		
Type	VABF-S1-1-P1A3-G38	VABF-S1-2-P1A3-G12
Based on standard	ISO 5599-1	
Pneumatic vertical stacking	Alternative compressed air supply for 1	
Mounting position	Any	
Type of mounting	On individual sub-base, on manifold sub-base	
Standard nominal flow rate [l/min]	1300	2800
Pneumatic port 1	G3/8	G1/2
Degree of protection	IP65 NEMA4	IP65 NEMA4

Materials	
Housing	Die-cast aluminium
Note on materials	RoHS-compliant

Operating and environmental conditions		
Type	VABF-S1-1-P1A3-G38	VABF-S1-2-P1A3-G12
Operating medium	Compressed air to ISO 8573-1:2010 [7:4:4]	
Note on operating/pilot medium	Lubricated operation possible (in which case lubricated operation will always be required)	
Operating pressure [bar]	-0.9 ... +10	-0.9 ... +10
Supply pressure 1 [bar]	-	+0.5 ... +10
Ambient temperature [°C]	-5 ... +50	-5 ... +50

Standard valves to ISO 5599-1, vertical supply plate

Accessories

Dimensions

Download CAD data → www.festo.com/en/engineering

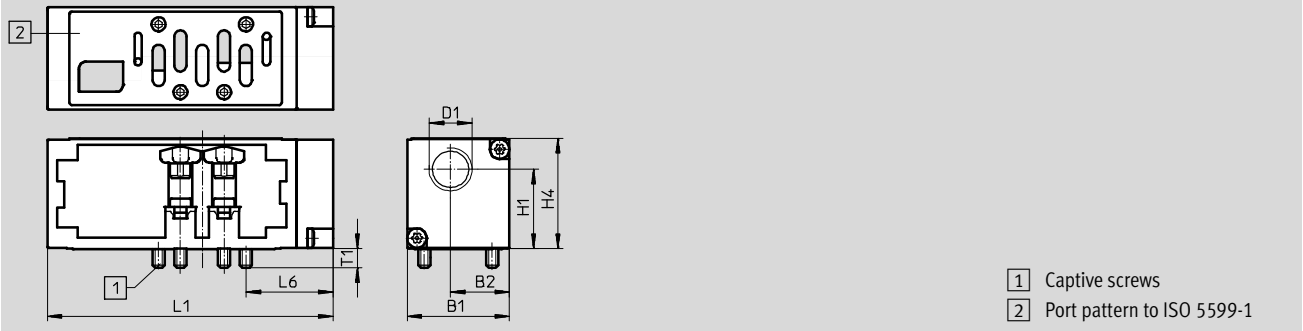

Type	B1	B2	D1	H1	H4	L1	L6	T1
VABF-S1-1-P1A3-G38	42.1	24.2	G3/8	32.7	45.3	117.6	35.8	7.9
VABF-S1-2-P1A3-G12	54	31	G1/2	42.4	58.9	136	38	10

Ordering data

Circuit symbol	Description	Width	Standard nominal flow rate [l/min]	Weight [g]	Part No.	Type
	Vertical supply plate	42 mm	1300	340	549100	VABF-S1-1-P1A3-G38
		52 mm	2800	605	555785	VABF-S1-2-P1A3-G12

Standard valves to ISO 5599-1, vertical pressure shut-off plate

Accessories

Function

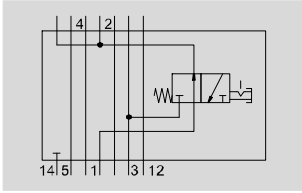

Vertical pressure shut-off plate for blocking duct 1 and duct 14 upstream of a valve.



General technical data		
Type	VABF-S1-1-L1D1-C	VABF-S1-2-L1D1-C
Based on standard	ISO 5599-1	
Pneumatic vertical stacking	Shut-off for 1	Alternative compressed air supply for 1
Mounting position	Any	
Type of mounting	On individual sub-base, on manifold sub-base	
Standard nominal flow rate [l/min]	1200	1950
Pneumatic port 1	G3/8	G1/2
Degree of protection	IP65	IP65
	NEMA4	NEMA4

Materials	
Housing	Die-cast aluminium
Note on materials	RoHS-compliant

Operating and environmental conditions		
Type	VABF-S1-1-L1D1-C	VABF-S1-2-L1D1-C
Operating medium	Compressed air to ISO 8573-1:2010 [7:4:4]	
Note on operating/pilot medium	Lubricated operation possible (in which case lubricated operation will always be required)	
Operating pressure [bar]	-0.9 ... +10	-0.9 ... +10
Supply pressure 1 [bar]	-	+0.5 ... +10
Ambient temperature [°C]	-5 ... +50	-5 ... +50

Standard valves to ISO 5599-1, vertical pressure shut-off plate

Accessories

Dimensions

Download CAD data → www.festo.com/en/engineering

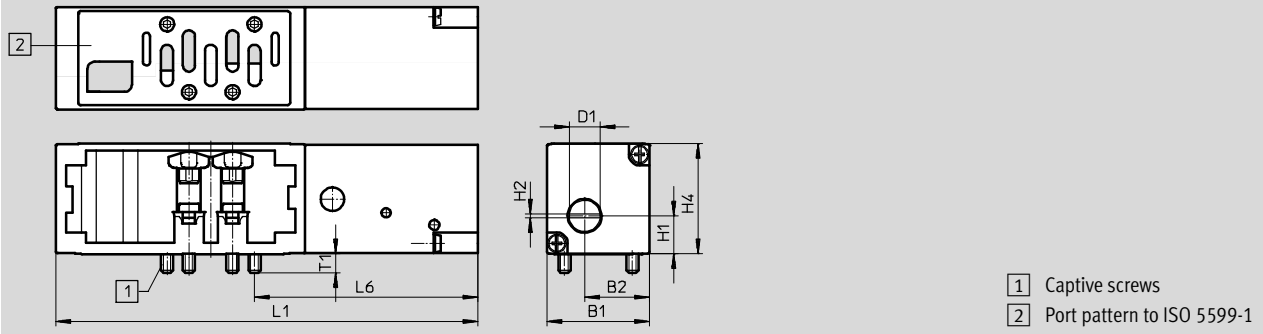

Type	B1	B2	D1	H1	H2	H4	L1	L6	T1
VABF-S1-1-L1D1-C	42.1	26.7	12.8	15.6	1.6	45.3	173.8	92	7.9
VABF-S1-2-L1D1-C	54	32.6	14	21.3	1.6	58.7	191.2	93.2	10

Ordering data

Circuit symbol	Description	Width	Standard nominal flow rate [l/min]	Weight [g]	Part No.	Type
	Vertical pressure shut-off plate	42 mm	1200	600	549103	VABF-S1-1-L1D1-C
		52 mm	1950	1030	555790	VABF-S1-2-L1D1-C

Standard valves to ISO 5599-1, pressure regulator

Accessories



Function

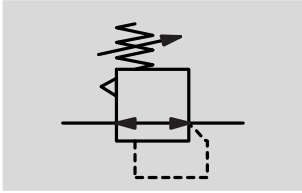

The pressure regulator enables the manual setting of a particular pressure in the regulated port upstream or downstream of the valve.

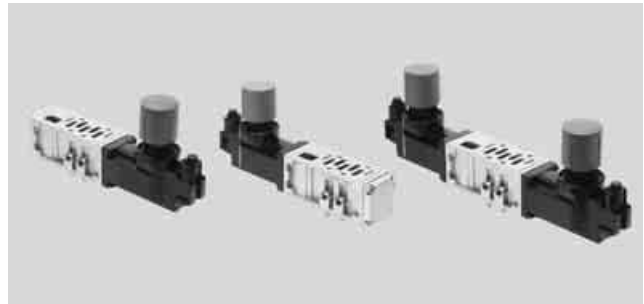

General technical data				
Type	VABF-S1-1-R...	VABF-S1-2-R...	LR-ZP-...-3	
Width [mm]	42	52	65	
Based on standard	ISO 5599-1	ISO 5599-1	ISO 5599-1	
Pneumatic vertical stacking	Pressure regulator	Pressure regulator	Pressure regulator	
Design	–	–	Piston	
Regulator function	Output pressure constant	Output pressure constant	–	
	With secondary venting	With secondary venting	–	
Mounting position	Any	Any	–	
Type of mounting	On individual sub-base	On individual sub-base	–	
	On manifold sub-base	On manifold sub-base	–	
Optional pressure gauge	Possible	Possible	–	
Pressure gauge connection	With retaining clamp	With retaining clamp	–	
Degree of protection	IP65	IP65	–	
	NEMA4	NEMA4	–	

Materials				
Type	VABF-S1-1-R...	VABF-S1-2-R...	LR-ZP-...-3	
Regulator housing	Die-cast aluminium	Die-cast aluminium	Die-cast aluminium, steel	
Control section	PA	PA	–	
Seals	–	–	NBR	
Note on materials	RoHS-compliant	RoHS-compliant	RoHS-compliant	
	PWIS-free	PWIS-free	Contains PWIS (paint-wetting impairment substances)	

Operating and environmental conditions				
Type	VABF-S1-1-R...	VABF-S1-2-R...	LR-ZP-...-3	
Operating medium	Compressed air to ISO 8573-1:2010 [7:4:4]		–	
Note on operating/pilot medium	Lubricated operation possible (in which case lubricated operation will always be required)		–	
Supply pressure 1 [bar]	+0.5 ... +10	+0.5 ... +10	Max. 14	
Ambient temperature [°C]	–5 ... +50	–5 ... +50	–	
Certification	–	–	UL Recognised (OL)	

Product weight				
Type	VABF-S1-1-R...	VABF-S1-2-R...	LR-ZP-...-3	
Regulated port	1	640 g	1190 g	1220 g
	2	640 g	1230 g	1220 g
	4	640 g	1230 g	1220 g
	2 and 4	920 g	1990 g	1770 g

Standard valves to ISO 5599-1, pressure regulator

Accessories

Dimensions

Download CAD data → www.festo.com

VABF-S1-1-..., VABF-S1-2-...

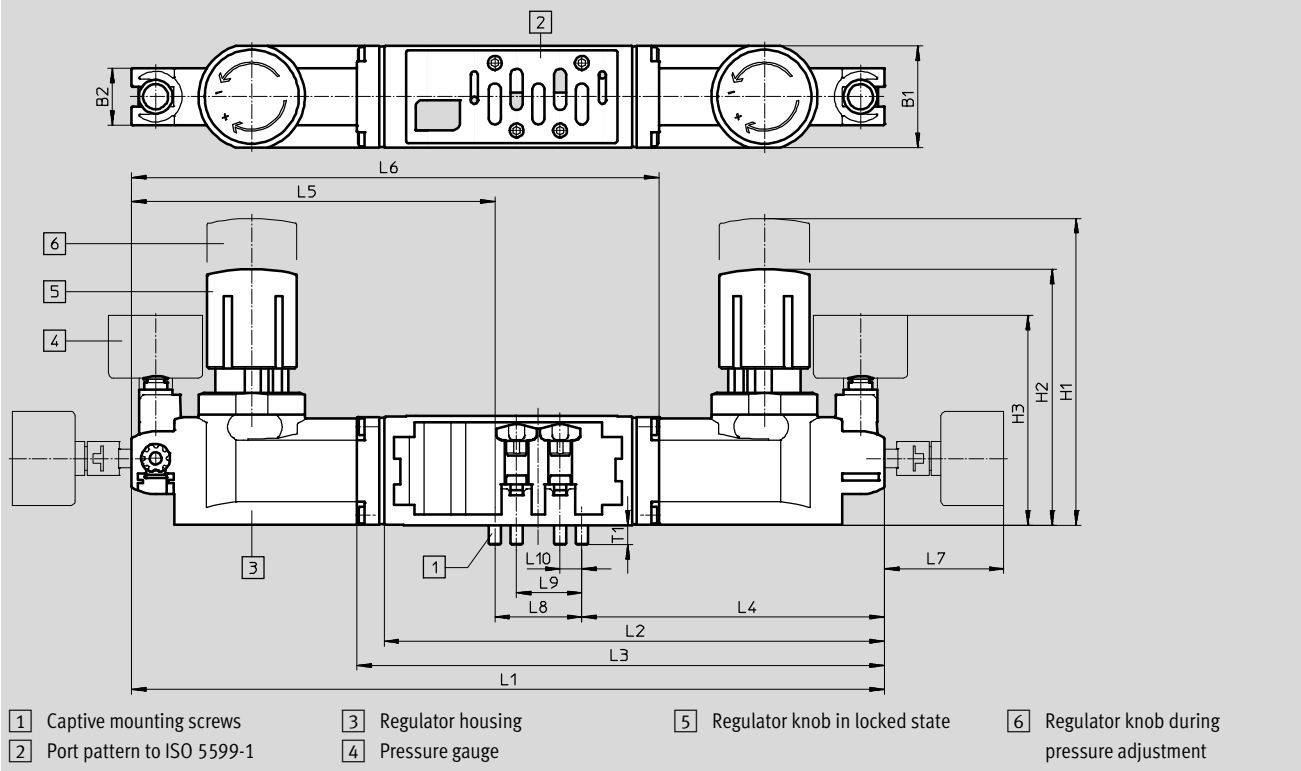

Type	B1	B2	H1	H2	H3	L1	L2	L3	L4	L5	L6	L7	L8	L9	L10	T1
Regulator plate, width 42 mm																
VABF-S1-1-R1...	42.1	23.6	115	112	87.1	-	207.1	-	125.3	-	-	49.4	36	27	9	7.9
VABF-S1-1-R2...						-	-	216.2	125.3	-	-					
VABF-S1-1-R3...						-	-	-	125.3	150.3	216.1					
VABF-S1-1-R4...						311.6	-	-	-	-	-					
VABF-S1-1-R5...						311.6	-	-	-	-	-					
VABF-S1-1-R6...						-	-	216.2	125.3	-	-					
VABF-S1-1-R7...						-	-	-	125.3	150.3	216.1					
Regulator plate, width 52 mm																
VABF-S1-2-R1...	54	23.6	182	167	94.4	-	250.2	-	152.2	-	-	49.4	48	38	12	10
VABF-S1-2-R2...						-	-	264.2	152.2	-	-					
VABF-S1-2-R3...						-	-	-	152.2	180.2	264.2					
VABF-S1-2-R4...						380.4	-	-	-	-	-					
VABF-S1-2-R5...						380.4	-	-	-	-	-					
VABF-S1-2-R6...						-	-	264.2	152.2	-	-					
VABF-S1-2-R7...						-	-	-	152.2	180.2	264.2					

Standard valves to ISO 5599-1, pressure regulator

Accessories

Dimensions

Download CAD data → www.festo.com

LR-ZP-...-3

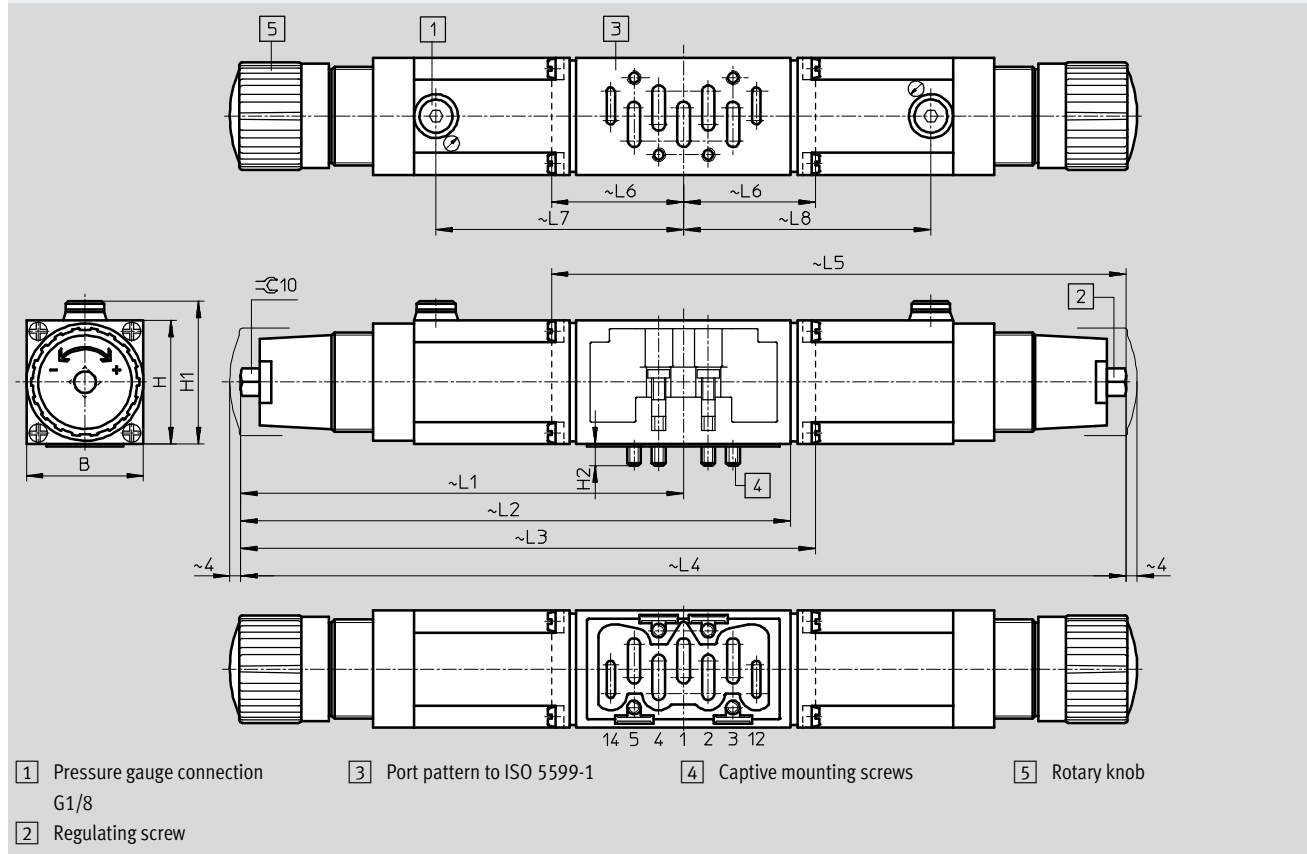

Type	B	H	H1	H2	L1	L2	L3	L4	L5	L6	L7	L8
Regulator plate, width 65 mm												
LR-ZP-P-D-3	70	63	65	14	201.5	-	274	-	-	-	119	-
LR-ZP-B-D-3					201.5	-	-	-	274	72.5	-	119
LR-ZP-A-D-3					201.5	-	-	403	-	-	119	119
LR-ZP-A/B-D-3					201.5	260	-	-	-	-	119	-

Flow rate q_n as a function of output pressure p_2

LR-ZP-A-D-3, LR-ZP-B-D-3, LR-ZP-A/B-D-3

LR-ZP-P-D-3

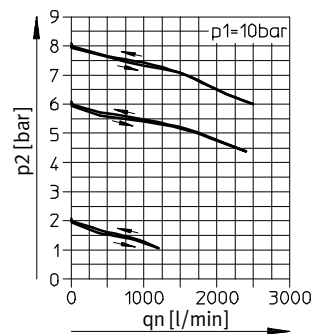
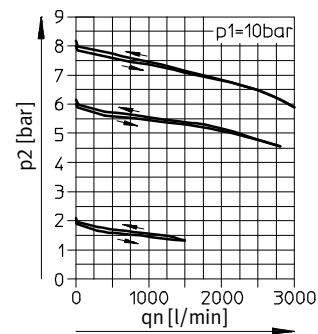

Standard valves to ISO 5599-1, pressure regulator

Accessories

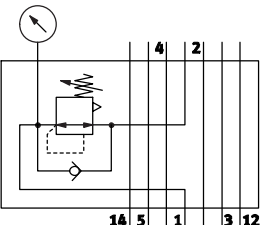
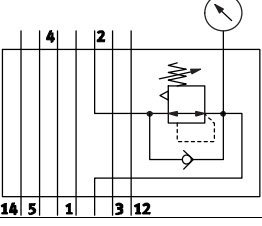
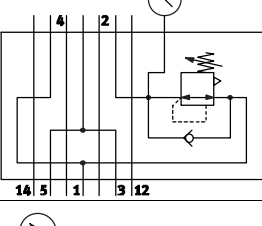
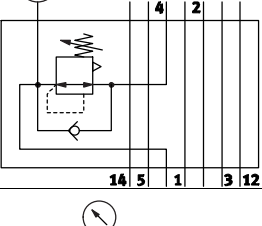
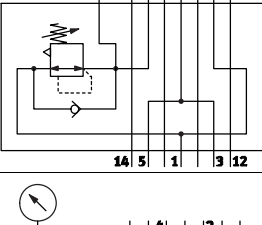
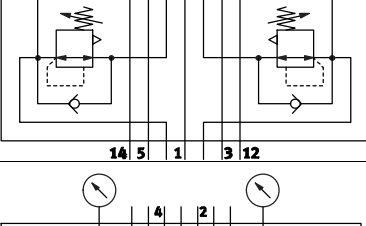
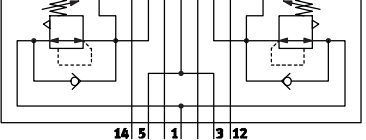
Ordering data					
	Regulated port	Regulator	Control range	Part No.	Type
Regulator plate, width 42 mm					
	1	P	0.5 ... 6 bar	546817	VABF-S1-1-R1C2-C-6
			0.5 ... 10 bar	546818	VABF-S1-1-R1C2-C-10
	2	B	1 ... 6 bar	546821	VABF-S1-1-R2C2-C-6
			1 ... 10 bar	546822	VABF-S1-1-R2C2-C-10
	2, reversible	B	0.5 ... 6 bar	546827	VABF-S1-1-R6C2-C-6
			0.5 ... 10 bar	546828	VABF-S1-1-R6C2-C-10
	4	A	1 ... 6 bar	546819	VABF-S1-1-R3C2-C-6
			1 ... 10 bar	546820	VABF-S1-1-R3C2-C-10
	4, reversible	A	0.5 ... 6 bar	546829	VABF-S1-1-R7C2-C-6
			0.5 ... 10 bar	546830	VABF-S1-1-R7C2-C-10
	2 and 4	AB	1 ... 6 bar	546823	VABF-S1-1-R4C2-C-6
			1 ... 10 bar	546824	VABF-S1-1-R4C2-C-10
	2 and 4, reversible	AB	0.5 ... 6 bar	546825	VABF-S1-1-R5C2-C-6
			0.5 ... 10 bar	546826	VABF-S1-1-R5C2-C-10

Standard valves to ISO 5599-1, pressure regulator

Accessories

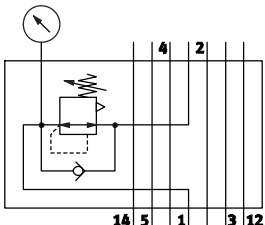
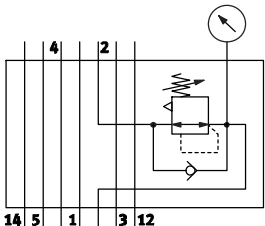
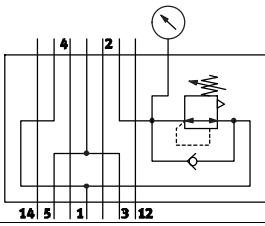
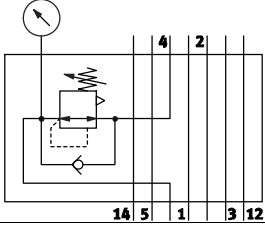
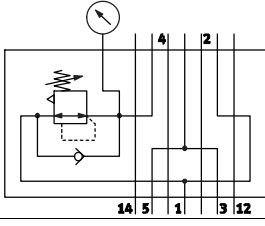
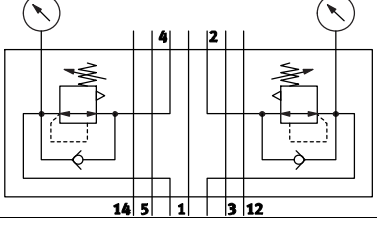
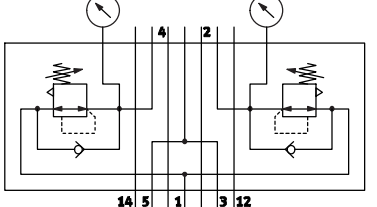
Ordering data					
	Regulated port	Regulator	Control range	Part No.	Type
Regulator plate, width 52 mm					
	1	P	0.5 ... 6 bar	555757	VABF-S1-2-R1C2-C-6
			0.5 ... 10 bar	555758	VABF-S1-2-R1C2-C-10
	2	B	1 ... 6 bar	555759	VABF-S1-2-R2C2-C-6
			1 ... 10 bar	555760	VABF-S1-2-R2C2-C-10
	2, reversible	B	0.5 ... 6 bar	555767	VABF-S1-2-R6C2-C-6
			0.5 ... 10 bar	555768	VABF-S1-2-R6C2-C-10
	4	A	1 ... 6 bar	555761	VABF-S1-2-R3C2-C-6
			1 ... 10 bar	555762	VABF-S1-2-R3C2-C-10
	4, reversible	A	0.5 ... 6 bar	555769	VABF-S1-2-R7C2-C-6
			0.5 ... 10 bar	555770	VABF-S1-2-R7C2-C-10
	2 and 4	AB	1 ... 6 bar	555763	VABF-S1-2-R4C2-C-6
			1 ... 10 bar	555764	VABF-S1-2-R4C2-C-10
	2 and 4, reversible	AB	0.5 ... 6 bar	555765	VABF-S1-2-R5C2-C-6
			0.5 ... 10 bar	555766	VABF-S1-2-R5C2-C-10

Standard valves to ISO 5599-1, pressure regulator

Accessories

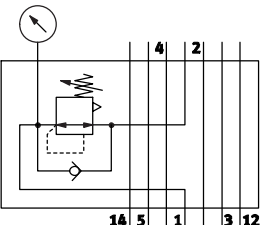
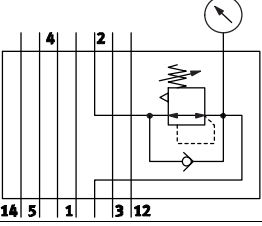
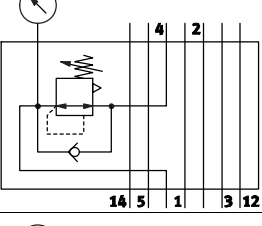
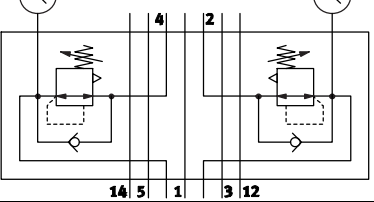
Ordering data					
	Regulated port	Regulator	Control range	Part No.	Type
Regulator plate, width 65 mm					
	1	P	0 ... 12 bar	35968	LR-ZP-P-D-3
	2	B	0 ... 12 bar	35426	LR-ZP-B-D-3
	4	A	0 ... 12 bar	35971	LR-ZP-A-D-3
	2, 4	AB	0.5 ... 12 bar	35429	LR-ZP-A/B-D-3



Ordering data – Accessories				
	Width	Weight [g]	Part No.	Type
Pressure gauge for intermediate pressure regulator plates LR-ZP	65 mm	64.5	345395	MA-40-16-1/8

· || · Note: This product conforms to ISO 1179-1 and to ISO 228-1

Standard valves to ISO 5599-1

Accessories

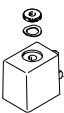
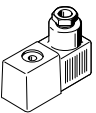
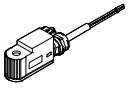



FESTO

Ordering data					
	Description	Voltage	Cable length [m]	Part No.	Type
Solenoid coil MSF					
	Solenoid coil	12 V DC	–	34410	MSFG-12DC-OD
		24 V DC and 42 V AC, 50 ... 60 Hz	–	34411	MSFG-24/42-50/60-OD
		42 V DC	–	34413	MSFG-42DC-OD
		24 V AC	–	34415	MSFG-24AC-OD
		48 V AC, 50 ... 60 Hz	–	34418	MSFW-48AC-OD
		110 V AC, 50 ... 60 Hz and 120 V AC, 60 Hz	–	34420	MSFW-110AC-OD
		230 V AC, 50 ... 60 Hz and 240 V AC, 60 Hz	–	34422	MSFW-230AC-OD
		240 V AC, 50 ... 60 Hz	–	34424	MSFW-240AC-OD
	Solenoid coil with socket MSSD	12 V DC	–	4526	MSFG-12
		24 V DC and 42 V AC, 50 ... 60 Hz	–	4527	MSFG-24/42-50/60
		24 V AC	–	4534	MSFW-24-50/60
		110 V AC, 50 ... 60 Hz and 120 V AC, 60 Hz	–	6720	MSFW-110-50/60
		230 V AC, 50 ... 60 Hz and 240 V AC, 60 Hz	–	4540	MSFW-230-50/60
	Solenoid coil for ATEX environment	24 V DC	1	8059804	VACF-B-K1-1-1-EX4-M
			5	8059805	VACF-B-K1-1-5-EX4-M
		24 V AC, 50 ... 60 Hz	1	8059808	VACF-B-K1-1A-1-EX4-M
			5	8059812	VACF-B-K1-16B-5-EX4-M
		110 V AC, 50 ... 60 Hz	1	8059811	VACF-B-K1-16B-1-EX4-M
		230 V AC, 50 ... 60 Hz	1	8059809	VACF-B-K1-3A-1-EX4-M
			5	8059810	VACF-B-K1-3A-5-EX4-M
Solenoid coil MSN1					
	Solenoid coil	24 V DC	–	123060	MSN1G-24DC-OD
		12 V DC and 24 V AC, 50 ... 60 Hz	–	170152	MSN1W-24AC/12DC
		110 V AC, 50 ... 60 Hz	–	123061	MSN1W-110AC-OD
		230 V AC, 50 ... 60 Hz	–	123062	MSN1W-230AC-OD

Standard valves to ISO 5599-1

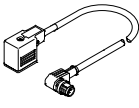
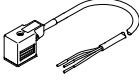
Accessories

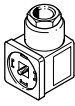
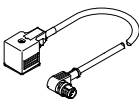
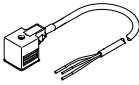



FESTO

Ordering data						
	Description			Cable length [m]	Part No.	Type
Electrical accessories for solenoid coil MSF						
	Angled socket	Screw terminal	Cable conduit fitting Pg9	–	34431	MSSD-F
			Cable conduit fitting M16	–	59710	MSSD-F-M16
		Insulation displacement connection	Cable conduit fitting M16	–	192746	MSSD-F-S-M16
	PUR cable coating, connection technology M12x1, A-coded	24 AC/DC	• Signal status display	0.3	3679773	NEBV-B2W3F-P-K-0.3-N-M12W3
			• Protective circuit	0.6	3679774	NEBV-B2W3F-P-K-0.6-N-M12W3
		110 AC/DC	–	0.3	3579463	NEBV-B2W3-K-0.3-N-M12W3
			–	0.6	3579464	NEBV-B2W3-K-0.6-N-M12W3
	PUR cable coating	24 AC/DC	• Signal status display	0.6	3679778	NEBV-B2W3F-P-K-0.6-N-LE3
		230 AC/DC	–			
	PVC cable coating	24 V DC	Signal status display	2.5	30935	KMF-1-24DC-2,5-LED
				5	30937	KMF-1-24DC-5-LED
10				193458	KMF-1-24DC-10-LED	
230 V AC		–	2.5	30936	KMF-1-230AC-2,5	
			5	30938	KMF-1-230AC-5	
	Illuminating seal	12 ... 24 V DC	Signal status display	–	19143	MF-LD-12-24DC
		230 V DC/V AC	Signal status display	–	19144	MF-LD-230AC
Electrical accessories for solenoid coil MSN1 and MD						
	Angled socket	Screw terminal	Cable conduit fitting Pg9	–	34583	MSSD-C
			Cable conduit fitting M16	–	539709	MSSD-C-M16
		Insulation displacement connection	Cable conduit fitting M16	–	192748	MSSD-C-S-M16
	PUR cable coating, connection technology M12x1, A-coded	24 AC/DC	• Signal status display	0.3	3679771	NEBV-A1W3F-P-K-0.3-N-M12W3
			• Protective circuit	0.6	3679772	NEBV-A1W3F-P-K-0.6-N-M12W3
		110 AC/DC	–	0.3	3579461	NEBV-A1W3-K-0.3-N-M12W3
			–	0.6	3579462	NEBV-A1W3-K-0.6-N-M12W3
	PUR cable coating	24 AC/DC	• Signal status display	0.6	3679776	NEBV-A1W3F-P-K-0.6-N-LE3
		230 AC/DC	–			
	PVC cable coating	24 V DC	Signal status display	2.5	30931	KMC-1-24DC-2,5-LED
				5	30933	KMC-1-24DC-5-LED
10				193459	KMC-1-24DC-10-LED	
230 V AC		–	2.5	30932	KMC-1-230AC-2,5	
			5	30934	KMC-1-230AC-5	
	Illuminating seal	12 ... 24 V DC	Signal status display	–	19145	MC-LD-12-24DC
		230 V DC/V AC	Signal status display	–	19146	MC-LD-230AC

Standard valves to ISO 5599-1

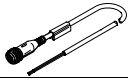
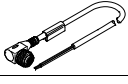
Accessories

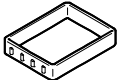
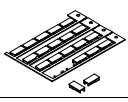
FESTO

Ordering data				
	Description		Part No.	Type
Electrical accessories for valves with central plug				
	Angled socket, M12, 4-pin, type A, screw terminal	–	12956	SIE-WD-TR
	Connecting cable, straight socket, M12x1, 5-pin, open cable end, 4-wire	2.5	550326	NEBU-M12G5-K-2,5-LE4
		5	541328	NEBU-M12G5-K-5-LE4
	Connecting cable, angled socket, M12x1, 5-pin, open cable end, 4-wire	2.5	550325	NEBU-M12W5-K-2,5-LE4
		5	541329	NEBU-M12W5-K-5-LE4
Pressure gauge				
	With cartridge connection for regulator	10 bar	543487	PAGN-26-16-P10
		6 bar	543488	PAGN-26-10-P10
Seal				
	Enables the valves with central plug M12, 3-pin, to be assembled on the sub-bases of the valve terminal VTSA/VTSA-F (2 included in the scope of delivery)		571343	VABD-S2-1-S-C
Inscription label				
	Inscription label for valves	Scope of delivery 24 labels in frame	161937	IBS-9x17
	Clip-on inscription label holder for valve cap, for valves with central plug M12, 3-pin	Scope of delivery 5 holders	540888	ASCF-T-S6
Manual override				
	Tool for manual override	Valves MN1H/MFH	157651	AHB-MD/MF/MV

Festo North America

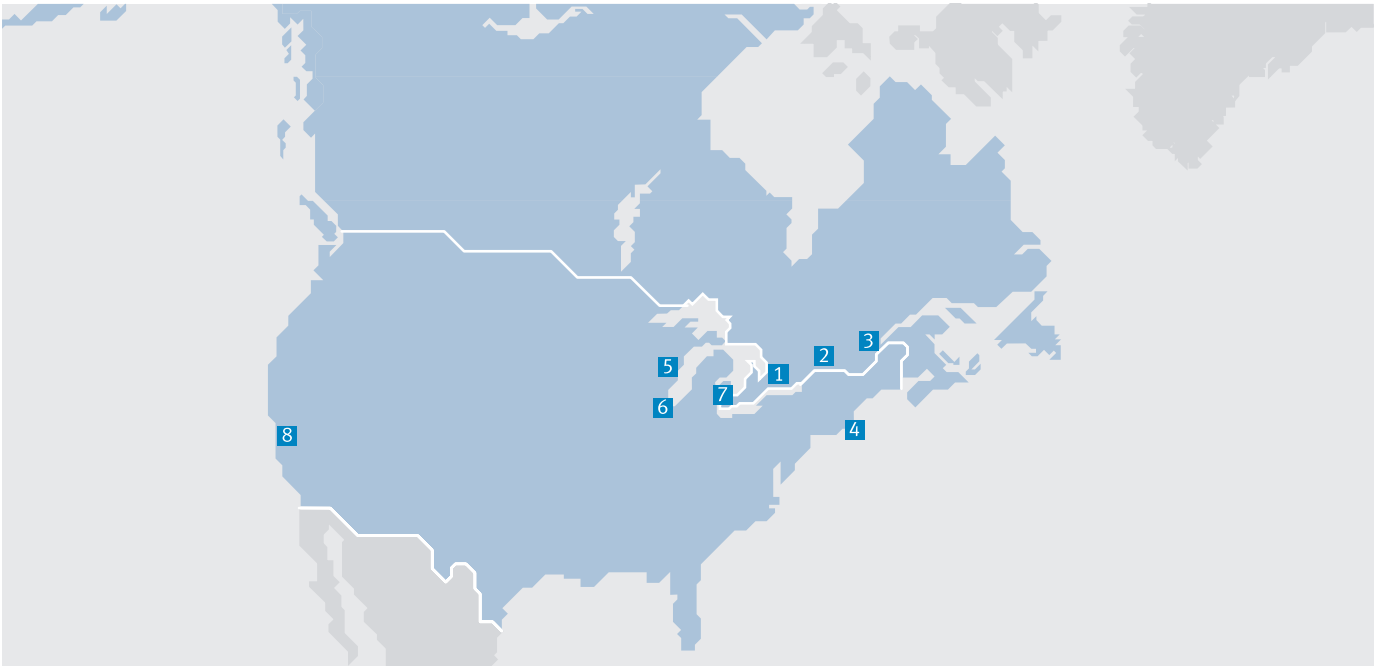

**1 Festo Canada
Headquarters
Festo Inc.**
5300 Explorer Drive
Mississauga, ON
L4W 5G4

2 Montréal
5600, Trans-Canada
Pointe-Claire, QC
H9R 1B6

3 Québec City
2930, rue Watt#117
Québec, QC
G1X 4G3



**4 Festo United States
Headquarters
Festo Corporation**
395 Moreland Road
Hauppauge, NY
11788

5 Appleton
North 922 Tower View Drive, Suite N
Greenville, WI
54942

7 Detroit
1441 West Long Lake Road
Troy, MI
48098

6 Chicago
85 W Algonquin - Suite 340
Arlington Heights, IL
60005

8 Silicon Valley
4935 Southfront Road, Suite F
Livermore, CA
94550

Festo Regional Contact Center

Canadian Customers

Commercial Support:
Tel: 1 877 GO FESTO (1 877 463 3786)
Fax: 1 877 FX FESTO (1 877 393 3786)
Email: festo.canada@ca.festo.com

Technical Support:
Tel: 1 866 GO FESTO (1 866 463 3786)
Fax: 1 877 FX FESTO (1 877 393 3786)
Email: technical.support@ca.festo.com

USA Customers

Commercial Support:
Tel: 1 800 99 FESTO (1 800 993 3786)
Fax: 1 800 96 FESTO (1 800 963 3786)
Email: customer.service@us.festo.com

Technical Support:
Tel: 1 866 GO FESTO (1 866 463 3786)
Fax: 1 800 96 FESTO (1 800 963 3786)
Email: product.support@us.festo.com