

Radial grippers DHRS



Radial grippers DHRS

Key features



At a glance

General information

- Lateral gripper jaw support for high torque loads
- Self-centring
- Gripper jaw centring options
- Max. repetition accuracy
- Gripping force retention
- Internal fixed flow control
- Wide range of options for mounting on drive units

- Sensor technology:
 - Adaptable position sensor for the small gripper sizes
 - Integratable proximity sensors for the medium and large gripper sizes

Flexible range of applications

- Can be used as a double-acting and single-acting gripper
- Compression spring for supplementary or retaining gripping forces
- Suitable for external and internal gripping

The technology in detail

Gripper closed

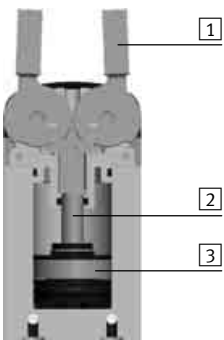

Gripper open

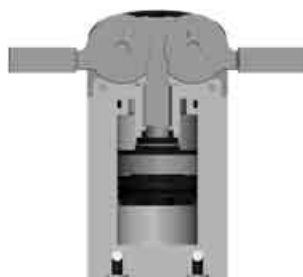

- 1 Gripper jaw
- 2 Slotted guide plate
- 3 Piston with magnet



Note

Gripper selection
sizing software

→ www.festo.com

Position sensing/force control

With position transmitter SMAT-8M, SDAT



Analogue positional feedback possible

- Analogue output
 - 0 ... 10 V
 - 4... 20 mA

With proportional pressure regulator VPPM



Infinite adjustment of the gripping force possible

- Setpoint input
 - 0 ... 10 V
 - 4 ... 20 mA

With proximity sensor SMT-8G



Multiple positions can be sensed:

- Open
- Closed
- Workpiece gripped

Radial grippers DHRS

Key features

Supply ports

At the side

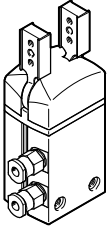

Mounting options

At the side

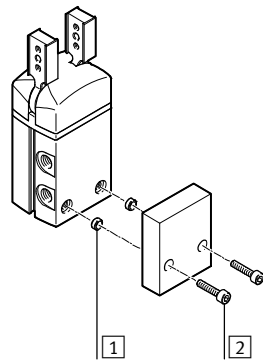
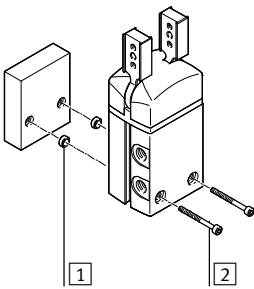

From underneath

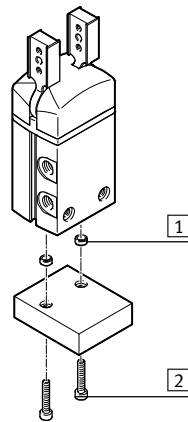

- 1 Centring sleeves
- 2 Mounting screws

Mounting options for external gripper fingers

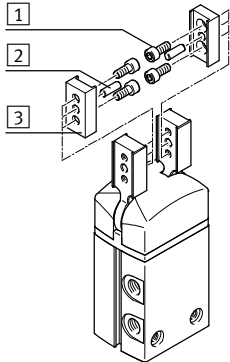

- 1 Mounting screws
- 2 Centring pins
- 3 Gripper fingers

Note

These grippers are not designed for the following or similar sample applications:

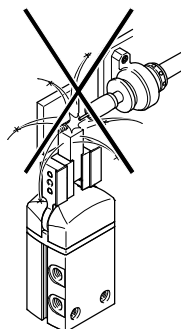

- Welding spatter

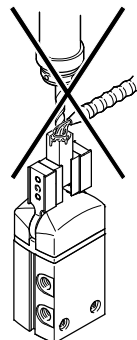

- Machining
- Aggressive media

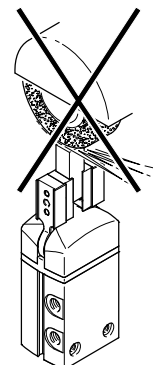

- Grinding dust

Radial grippers DHRS

Peripherals overview

FESTO

Peripherals overview

DHRS-10

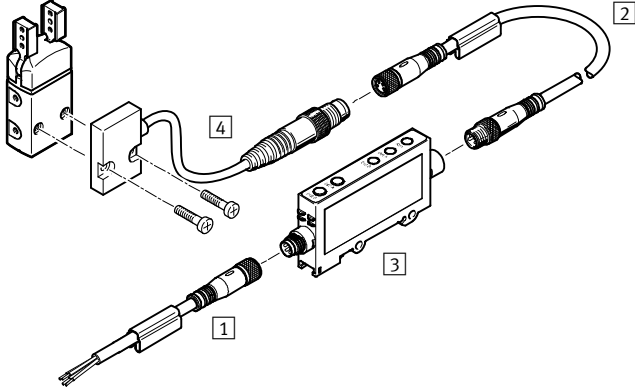

DHRS-16 ... 40

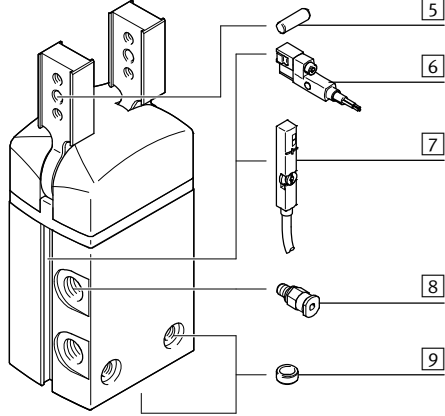

System product for handling and assembly technology

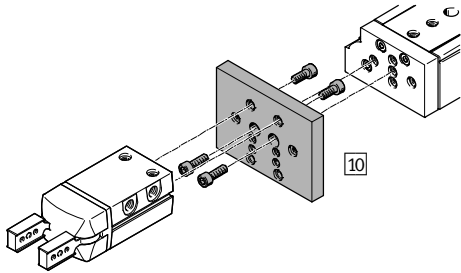

Proportional pressure regulator VPPM

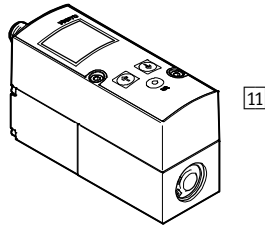

Radial grippers DHRS

Peripherals overview

| Accessories | | | | |
|-------------|---|-------------|---|------|
| Type | Size | Description | → Page/Internet | |
| 1 | Connecting cable NEBU | 10 | <ul style="list-style-type: none"> • Connection between signal converter and controller | 20 |
| 2 | Connecting cable NEBU | 10 | <ul style="list-style-type: none"> • Connection between position sensor and signal converter | 20 |
| 3 | Signal converter SVE4 | 10 | <ul style="list-style-type: none"> • For evaluating signals for position sensor SMH-S1 | 20 |
| 4 | Position sensor SMH-S1 | 10 | <ul style="list-style-type: none"> • Adaptable and integratable sensor technology, for sensing the piston position | 20 |
| 5 | Centring pin | 10 ... 40 | <ul style="list-style-type: none"> • For centring the gripper fingers on the gripper jaws | – |
| 6 | Proximity sensor SMT-8G | 16 ... 40 | <ul style="list-style-type: none"> • For sensing the piston position • Proximity sensor does not project past the housing at the bottom | 21 |
| 7 | Position transmitter SMAT-8M | 16 ... 40 | <ul style="list-style-type: none"> • Continuously senses the position of the piston. Has an analogue output with an output signal in proportion to the piston position | 21 |
| | Position transmitter SDAT | 32, 40 | | |
| 8 | Push-in fitting QS | 10 ... 40 | <ul style="list-style-type: none"> • For connecting compressed air tubing with standard O.D. | qs |
| 9 | Centring sleeve ZBH | 10 ... 40 | <ul style="list-style-type: none"> • For centring the gripper during mounting • The scope of delivery of the gripper includes 2 centring sleeves | 20 |
| 10 | Adapter kit DHAA, HMSV, HAPG, HAPS, HMVA | 10 ... 40 | <ul style="list-style-type: none"> • Connecting plate between drive and gripper | 16 |
| 11 | Proportional pressure regulator VPPM | 10 ... 40 | <ul style="list-style-type: none"> • For infinite adjustment of the gripping force | vppm |

Radial grippers DHRS

Type codes

| | | | | | | | | |
|---------------------------------|----------------------|------|---|----|---|---|---|--|
| | | DHRS | - | 16 | - | A | - | |
| Type | | | | | | | | |
| DHRS | Radial gripper | | | | | | | |
| Size | | | | | | | | |
| Position sensing | | | | | | | | |
| A | Via proximity sensor | | | | | | | |
| Gripping force retention | | | | | | | | |
| NC | Closing | | | | | | | |

Radial grippers DHRS

Technical data

FESTO

Function
Double-acting
DHRS-...-A

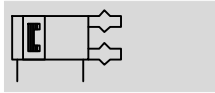

Size
10 ... 40 mm

Opening angle
180°

www.festo.com

Function – Variants
Single-acting or
with gripping force retention ...
... closing DHRS-...-NC



| General technical data | | | | | |
|-----------------------------------|---------------------------------------|----|--|------|------|
| Size | 10 | 16 | 25 | 32 | 40 |
| Design | Forced motion sequence | | | | |
| Mode of operation | Double-acting | | | | |
| Gripper function | Radial | | | | |
| Guide | Plain-bearing guide | | | | |
| Gripping force retention | – | NC | NC | NC | NC |
| Number of gripper jaws | 2 | | | | |
| Opening angle per gripper jaw | 90 | | | | |
| Pneumatic connection | M3 | M3 | M5 | G1/8 | G1/8 |
| Repetition accuracy ¹⁾ | ≤ 0.1 | | | | |
| Max. interchangeability | ≤ ±0.2 | | | | |
| Max. operating frequency | 4 | | | 3 | |
| Rotational symmetry | ≤ ∅ 0.2 | | | | |
| Position sensing | Via position sensor | | Via proximity sensor, position transmitter | | |
| Type of mounting | Via through-hole and centring sleeve | | | | |
| | Via female thread and centring sleeve | | | | |
| Mounting position | Any | | | | |

1) End-position drift under constant conditions of use with 100 consecutive strokes in the direction of movement of the gripper jaws

| Operating and environmental conditions | | | | | |
|--|--|----|----|----|----|
| Size | 10 | 16 | 25 | 32 | 40 |
| Min. operating pressure | | | | | |
| DHRS-...-A | [bar] 2 | | | | |
| DHRS-...-A-NC | [bar] – | | 4 | | |
| Max. operating pressure | [bar] 8 | | | | |
| Operating medium | Compressed air in accordance with ISO 8573-1:2010 [7:4:4] | | | | |
| Note on operating/pilot medium | Operation with lubricated medium possible (in which case lubricated operation will always be required) | | | | |
| Ambient temperature ¹⁾ | [°C] +5 ... +60 | | | | |
| Corrosion resistance class CRC ²⁾ | 1 | | | | |

1) Note operating range of proximity sensors

2) Corrosion resistance class CRC 1 to Festo standard FN 940070

Low corrosion stress. For dry indoor applications or transport and storage protection. Also applies to parts behind covers, in the non-visible interior area, and parts which are covered in the application (e.g. drive trunnions).

| Weight [g] | | | | | |
|---------------|----|-----|-----|-----|-----|
| Size | 10 | 16 | 25 | 32 | 40 |
| DHRS-...-A | 44 | 114 | 270 | 480 | 829 |
| DHRS-...-A-NC | – | 118 | 277 | 490 | 844 |

Radial grippers DHRS

Technical data

Materials

Sectional view

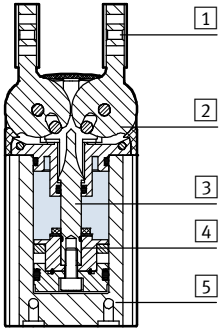

Radial gripper

| | | |
|---|---------------------|---|
| 1 | Gripper jaw | High-alloy stainless steel |
| 2 | Cover cap | Polyamide |
| 3 | Slotted guide plate | Tempered steel |
| 4 | Piston | Polyacetal |
| 5 | Housing | Hard anodised wrought aluminium alloy |
| - | Seals | Nitrile rubber |
| - | Note on materials | Free of copper and PTFE RoHS-compliant |

Total gripping torque [Ncm] at 6 bar

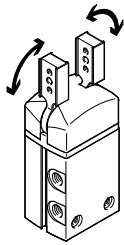

The gripping torque is not constant within the opening angle → page 12.

| Size | 10 | 16 | 25 | 32 | 40 | |
|------------|---------|----|----|-----|-----|-----|
| DHRS-...-A | Opening | 21 | 62 | 233 | 423 | 725 |
| | Closing | 15 | 55 | 215 | 390 | 660 |

Static characteristic load values at the gripper jaws

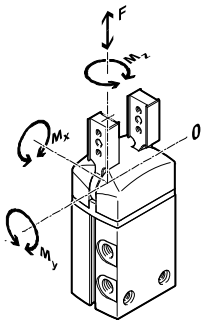

The indicated permissible forces and torques apply to a single gripper jaw. They include the lever arm, additional applied loads due to the workpiece or external gripper fingers and accelera-

tion forces occurring during movement.

The zero coordinate line (gripper jaw guide) must be taken into consideration for the calculation of torques.

| Size | | 10 | 16 | 25 | 32 | 40 |
|-------------------------------|------|-----|-----|-----|-----|-----|
| Max. permissible force F_z | [N] | 30 | 40 | 75 | 120 | 200 |
| Max. permissible torque M_x | [Nm] | 0.8 | 1.3 | 3.2 | 6.2 | 14 |
| Max. permissible torque M_y | [Nm] | 0.8 | 1.3 | 3.2 | 6.2 | 14 |
| Max. permissible torque M_z | [Nm] | 0.8 | 1.3 | 3.2 | 6.2 | 14 |

Mass moment of inertia [$\text{kgm}^2 \times 10^{-4}$]

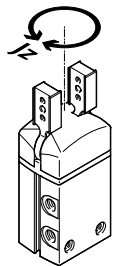

Mass moment of inertia of the radial gripper in relation to the central axis, without external gripper fingers, without load.

| Size | 10 | 16 | 25 | 32 | 40 |
|---------------|------|------|------|------|------|
| DHRS-...-A | 0.03 | 0.14 | 0.69 | 1.66 | 4.18 |
| DHRS-...-A-NC | - | 0.15 | 0.71 | 1.69 | 4.24 |

Radial grippers DHRS

Technical data

Opening and closing times [ms] at 6 bar

Without external gripper fingers

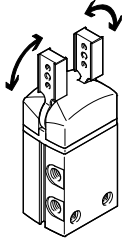

The indicated opening and closing times [ms] were measured at room temperature at an operating pressure of 6 bar with horizontally mounted grippers without additional gripper

fingers (average values). The grippers must be throttled for greater applied loads. Opening and closing times must then be adjusted accordingly.

| Size | | 10 | 16 | 25 | 32 | 40 |
|----------------------------------|---------|----|----|-----|-----|-----|
| Without external gripper fingers | | | | | | |
| DHRS...-A | Opening | 35 | 61 | 102 | 111 | 113 |
| | Closing | 91 | 63 | 105 | 119 | 142 |
| DHRS...-A-NC | Opening | - | 75 | 150 | 131 | 151 |
| | Closing | - | 43 | 96 | 88 | 110 |

Opening and closing times t to be set at 6 bar as a function of mass moment of inertia of the gripper fingers

DHRS-10

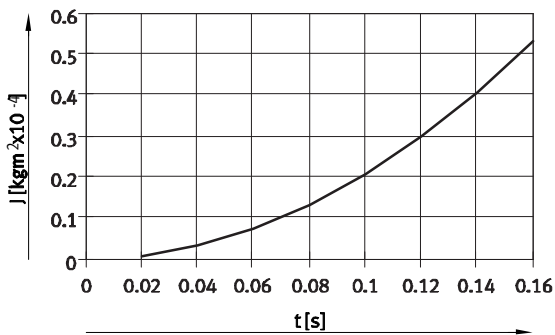

DHRS-16

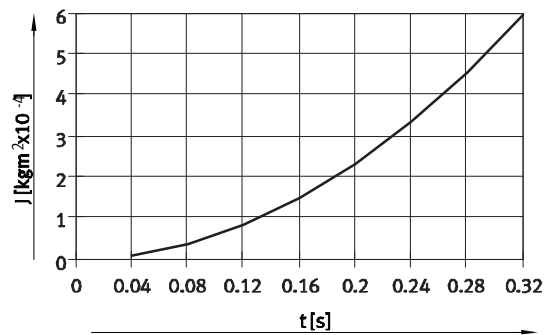

DHRS-25

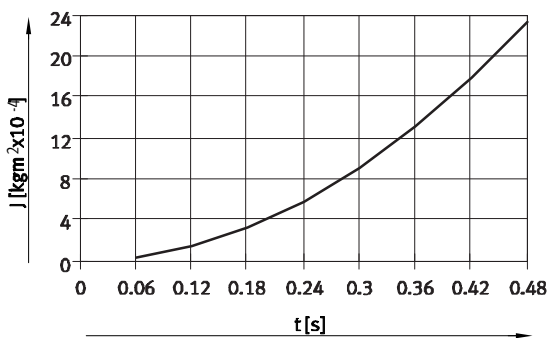

DHRS-32

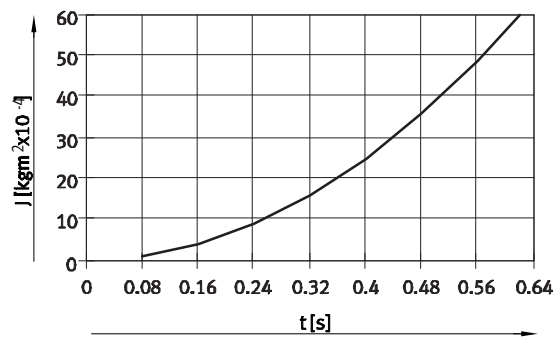

DHRS-40

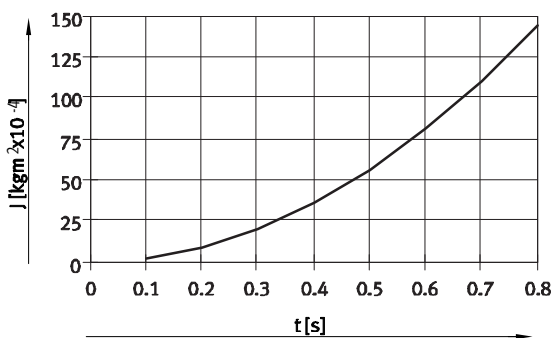

Radial grippers DHRS

Technical data

Gripping force F_H per gripper jaw as a function of operating pressure and lever arm x

The gripping forces as a function of operating pressure and lever arm can be determined from the following graphs.

The gripping torque is not constant within the opening angle → page 12.

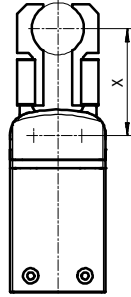

Note
Gripper selection
sizing software
→ www.festo.com

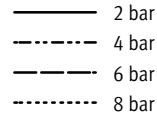

External gripping (closing)

DHRS-10

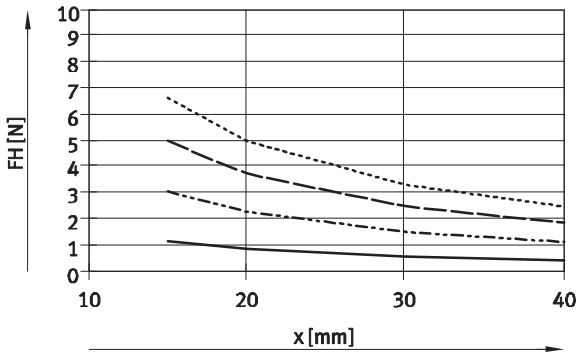

DHRS-16

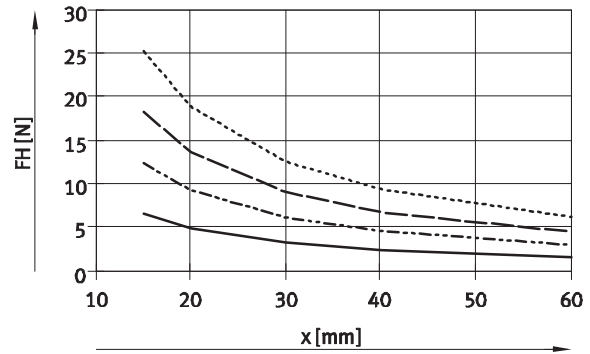

DHRS-25

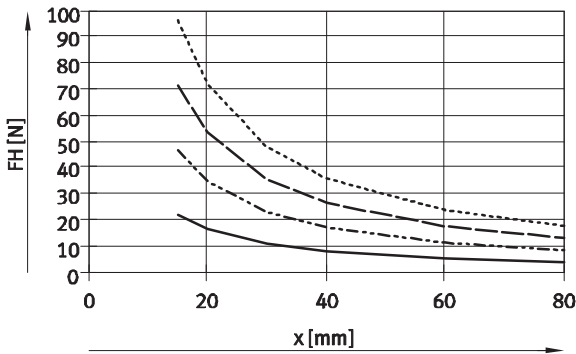

DHRS-32

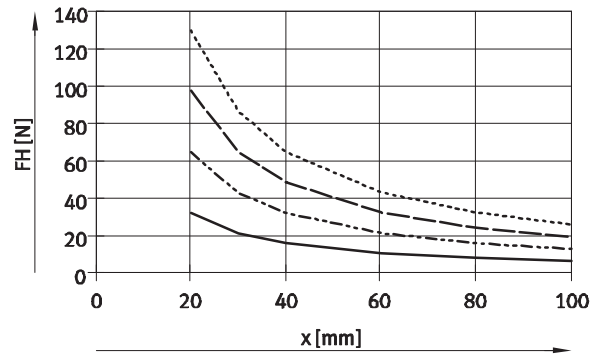

DHRS-40

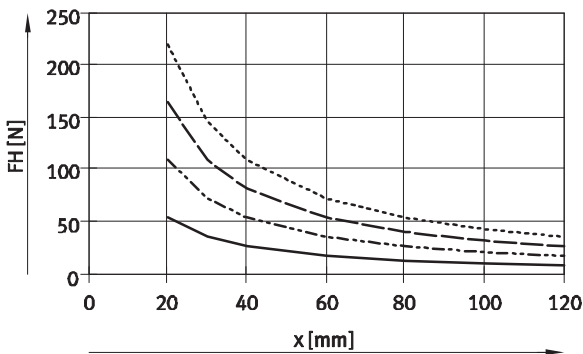

Radial grippers DHRS

Technical data

Gripping force F_H per gripper jaw as a function of operating pressure and lever arm x

The gripping forces as a function of operating pressure and lever arm can be determined from the following graphs.

The gripping torque is not constant within the opening angle → page 12.

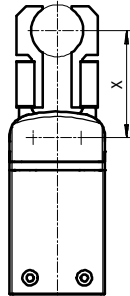

Note
Gripper selection
sizing software
→ www.festo.com

- 2 bar
- - - 4 bar
- · - 6 bar
- · · 8 bar

Internal gripping (opening)

DHRS-10

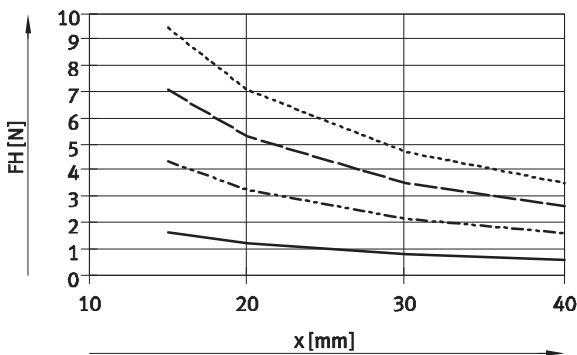

DHRS-16

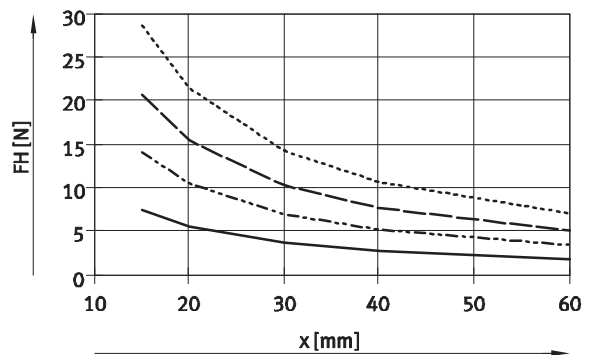

DHRS-25

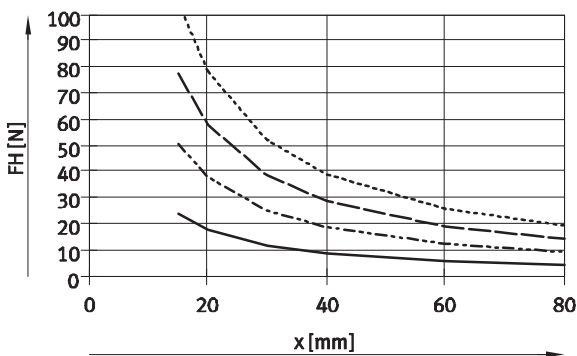

DHRS-32

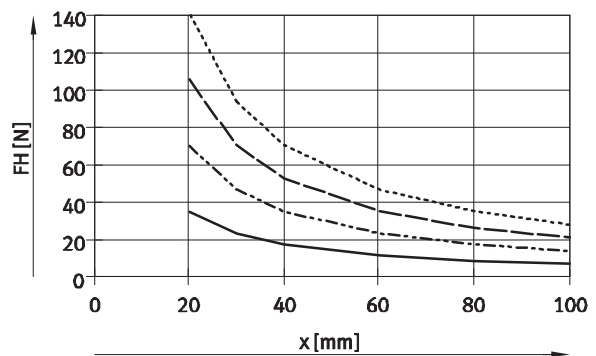

DHRS-40

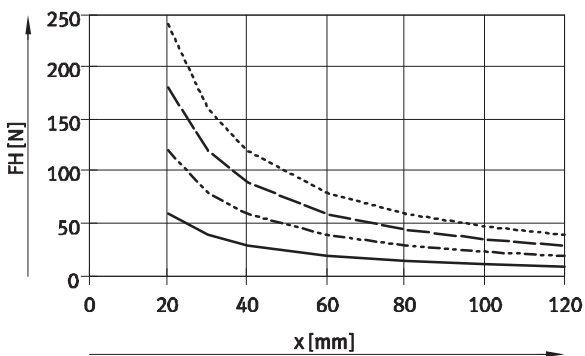

Radial grippers DHRS

Technical data

Gripping force F_H per gripper jaw at 6 bar as a function of lever arm x and eccentricity a and b

The following formula must be used to calculate the lever arm x with eccentric gripping:

$$x = \sqrt{a^2 + b^2}$$

The gripping force F_H can be read from the graphs (→ page 10/11) using the calculated value x .

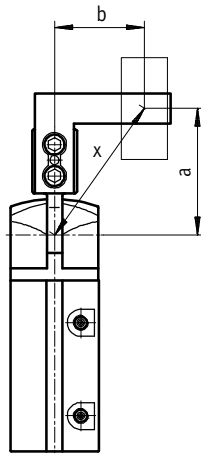

Calculation example

Given:

Distance $a = 25$ mm

Distance $b = 20$ mm

To be calculated:

The gripping force at 6 bar, with a DHRS-16, used as an external gripper

Procedure:

Calculating the lever arm x

$$x = \sqrt{25^2 + 20^2}$$

$$x = 32$$
 mm

The graph (→ page 10) gives a value of $F_H = 8$ N for the gripping force.

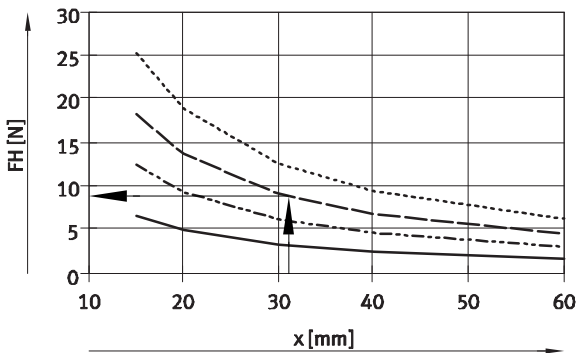

Torque curve M as a function of opening angle α

The drive principle of the gripper jaws means that the torque is not constant within the opening angle. The percentage of torque available in each case can be seen in the graph.

An opening angle of 0° means a parallel gripper jaw position.

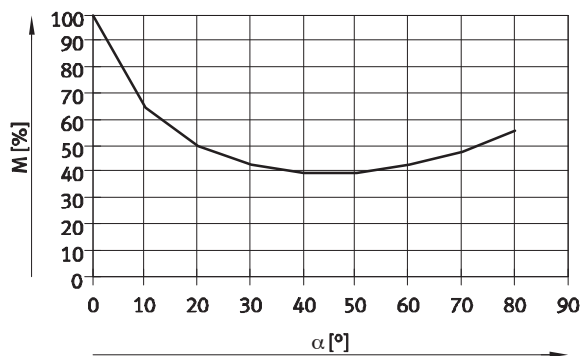

Radial grippers DHRS

Technical data

Spring torque M_F as a function of opening angle α

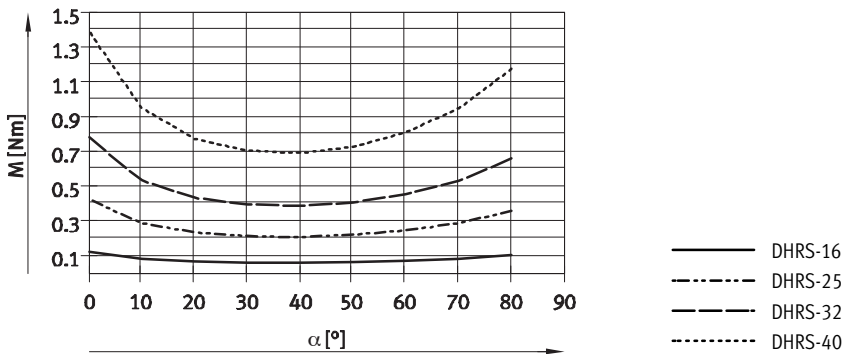

Determination of the actual gripping torques $M_{Grtotal}$ for DHRS-...-NC as a function of application

The radial gripper with integrated spring type DHRS-...-NC (closing gripping force retention) can be used as:

- single-acting grippers
- grippers with supplementary gripping force and
- grippers with gripping force retention depending on requirements.

In order to calculate the available gripping torque $M_{Grtotal}$ (per gripper jaw), the data from the graphs for the gripping force F_H (→ page 10/11),

the torque curve (→ page 12) and the spring torque M_F (→ page 13) must be combined accordingly.

$$M_{Gr} = F_H * x * M \text{ [%]}$$

M_{Gr} Gripping torque
 F_H Gripping force
 x Lever arm
 M Torque curve

Application

| Single-acting | Supplementary gripping force | Gripping force retention |
|---|--|--|
| <ul style="list-style-type: none"> • Gripping with spring force: $M_{Grtotal} = M_F$ • Gripping with pressure force: $M_{Grtotal} = M_{Gr} - M_F$ | <ul style="list-style-type: none"> • Gripping with pressure and spring force: $M_{Grtotal} = M_{Gr} + M_F$ | <ul style="list-style-type: none"> • Gripping with spring force: $M_{Grtotal} = M_F$ |

Radial grippers DHRS

Technical data

FESTO

Dimensions

Download CAD data → www.festo.com

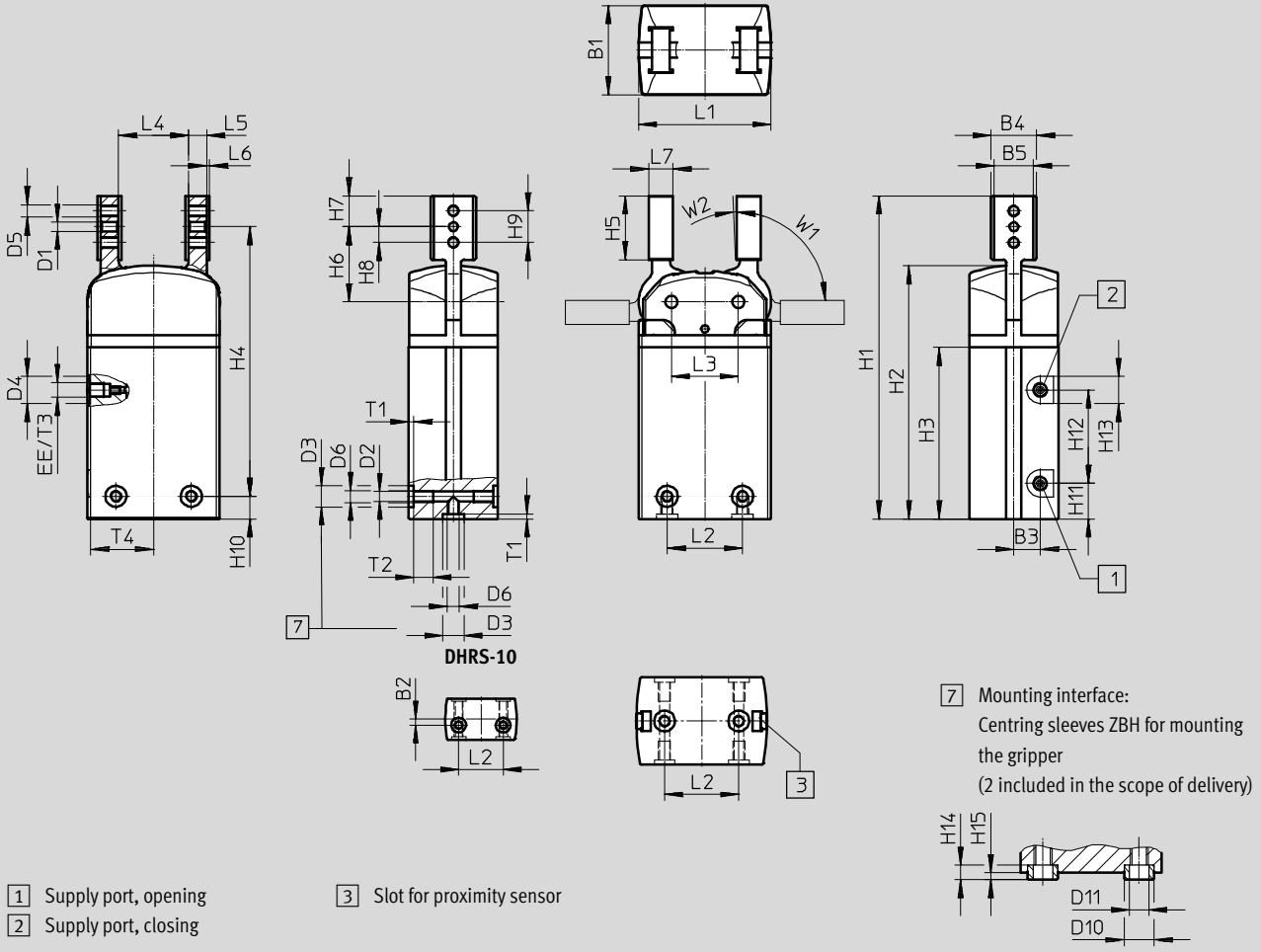

| Size | B1 | B2 ¹⁾ | B3 | B4 | B5 | D1 | D2 | D3 | D4 | D5 | D6 |
|------|-------|------------------|------|-----|-----------------|---------|-----------|------------|----|------|----|
| [mm] | ±0.05 | | | | +0.03/ +0.01 | ∅ H8 | ∅ +0.1 | ∅ H8/h7 | ∅ | | |
| 10 | 14 | 2 | 2 | 8.5 | 6.5 | 2 | 2.4 | 5 | 7 | M2.5 | M3 |
| 16 | 19 | – | 5.8 | 14 | 10 | 2 | 2.5 | 5 | – | M3 | M3 |
| 25 | 29.5 | – | 8.75 | 15 | 13 | 3 | 3.3 | 7 | 9 | M4 | M4 |
| 32 | 38 | – | 11 | 16 | 14 | 4 | 5.1 | 9 | 15 | M5 | M6 |
| 40 | 49 | – | 11 | 24 | 20 | 5 | 6.4 | 12 | 15 | M6 | M8 |

| Size | D10 | D11 | EE | H1 | H2 | H3 | H4 | H5 | H6 | H7 |
|------|---------|------|------|-------|-------|------|-------|------|-------|-------|
| [mm] | ∅ h7 | ∅ | | | | | ±0.25 | ±0.2 | ±0.05 | –0.1 |
| 10 | 5 | 3.2 | M3 | 60.8 | 46 | 30.8 | 42.25 | 13.8 | 14.95 | 6.25 |
| 16 | 5 | 3.2 | M3 | 88.2 | 70.5 | 49 | 73.7 | 16.5 | 19.7 | 7 |
| 25 | 7 | 5.3 | M5 | 107.2 | 84 | 57 | 89.45 | 21.2 | 24.95 | 10.25 |
| 32 | 9 | 6.4 | G1/8 | 128.5 | 96.2 | 65 | 103.5 | 29.5 | 32 | 14 |
| 40 | 12 | 10.3 | G1/8 | 140 | 108.4 | 71.5 | 108.7 | 29.5 | 33.7 | 13.8 |

1) Tolerance for centring hole ±0.02 mm; tolerance for thread ±0.1 mm

Radial grippers DHRS

Technical data

| Size [mm] | H8 | H9 | H10 ²⁾ | H11 | H12 | H13 | H14 | H15 | L1 | L2 ¹⁾ | L3 |
|--------------|------|------|-------------------|-------|-----|-----|------|------|-------|------------------|-------|
| | | | | | | | -0.2 | -0.3 | ±0.05 | | ±0.02 |
| 10 | 4 | 8 | 12.3 | 8.8 | 16 | 7 | 2.4 | 1.2 | 24 | 15 | 12.4 |
| 16 | 4 | 8 | 7.5 | 12.25 | 23 | 7 | 2.4 | 1.2 | 33.4 | 16 | 17 |
| 25 | 5.25 | 10.5 | 7.5 | 11.8 | 31 | 9 | 3 | 1.4 | 44 | 25 | 22.2 |
| 32 | 7 | 14 | 11 | 20 | 25 | 15 | 4 | 1.9 | 51 | 29 | 25.8 |
| 40 | 8 | 16 | 17.5 | 9 | 46 | 15 | 5 | 2.4 | 59 | 33 | 30 |

| Size [mm] | L4 | L5 | L6 | L7 | T1 | T2 | T3 | T4 | W1 | W2 |
|--------------|------|-------|-----|----|------|---------|------|------|-----|-----|
| | | ±0.05 | | | +0.1 | +1 | +0.5 | | ±2° | +3° |
| 10 | 12 | 4 | 0.5 | 5 | 1.2 | through | 3.5 | 11.6 | 90 | 2 |
| 16 | 21 | 4 | 1 | 6 | 1.2 | 5.8 | 4.5 | 16 | 90 | 2 |
| 25 | 23.2 | 6 | 1 | 8 | 1.6 | 6.4 | 4.5 | 21 | 90 | 2 |
| 32 | 24.8 | 8 | 1 | 10 | 2.1 | 12.9 | 6.5 | 24 | 90 | 2 |
| 40 | 29.6 | 10 | 1 | 12 | 2.6 | 13.4 | 6 | 28.4 | 90 | 2 |

1) Tolerance for centring hole ±0.02 mm, tolerance for thread ±0.1 mm

2) Tolerance for centring hole -0.05 mm, tolerance for thread ±0.1 mm

| Ordering data | | | | | |
|---------------|---|-----------|--|--------------|--|
| Size [mm] | Double-acting without compression spring | | Single-acting or with gripping force retention | | |
| | Part No. | Type | Closing | | |
| | Part No. | Type | Part No. | Type | |
| 10 | 1310159 | DHRS-10-A | - | | |
| 16 | 1310160 | DHRS-16-A | 1310161 | DHRS-16-A-NC | |
| 25 | 1310162 | DHRS-25-A | 1310163 | DHRS-25-A-NC | |
| 32 | 1310164 | DHRS-32-A | 1310165 | DHRS-32-A-NC | |
| 40 | 1310166 | DHRS-40-A | 1310167 | DHRS-40-A-NC | |

Radial grippers DHRS



Accessories



Adapter kit
HAPG, HAPS, HMSV

Material:
Wrought aluminium alloy
Free of copper and PTFE
RoHS-compliant

 Note
The kit includes the individual mounting interface as well as the necessary mounting material.

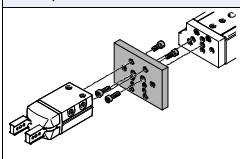
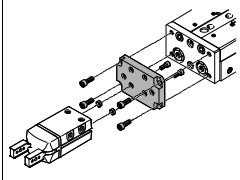
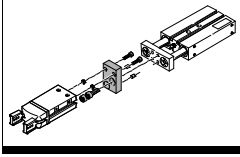
| Permissible drive/gripper combinations with adapter kit | | | | | | Download CAD data → www.festo.com | |
|---|---------------|-----------------|---|---|-------------------|--|---------|
| Combination | Drive Size | Gripper Size | Mounting option | | Adapter kit | | |
| | | |  |  | CRC ¹⁾ | Part No. | Type |
| | | | | | | | |
|  | DGSL | DHRS | | | HMSV | | |
| | 8, 10 | 10 | ■ | ■ | 2 | 548784 | HMSV-54 |
| | 12, 16 | 16 | ■ | ■ | | 548785 | HMSV-55 |
| | 20, 25 | 25, 32 | ■ | ■ | | 548786 | HMSV-56 |
|  | SLT | DHRS | | | HAPS | | |
| | 10 | 10 | ■ | – | 2 | 178448 | HAPS-2 |
| | 16 | 16 | ■ | – | | 178449 | HAPS-3 |
| | 20 | 25 | ■ | – | | 178450 | HAPS-4 |
| | 25 | 32 | ■ | – | | 178451 | HAPS-5 |
|  | DPZ | DHRS | | | HAPG | | |
| | 10, 16 | 16 | ■ | – | 2 | 163250 | HAPG-1 |
| | 16 | 25 | ■ | – | | 163251 | HAPG-2 |
| | 20 | 25 | ■ | – | | 163252 | HAPG-3 |
| | 25, 32 | 32 | ■ | – | | 163253 | HAPG-4 |

1) Corrosion resistance class CRC 2 to Festo standard FN 940070
Moderate corrosion stress. Indoor applications in which condensation may occur. External visible parts with primarily decorative requirements for the surface and which are in direct contact with the ambient atmosphere typical for industrial applications.

Radial grippers DHRS



Accessories



Adapter kit
DHAA, HAPG, HMSV, HMVA,

Material:
Wrought aluminium alloy
Free of copper and PTFE
RoHS-compliant

 Note
The kit includes the individual mounting interface as well as the necessary mounting material.

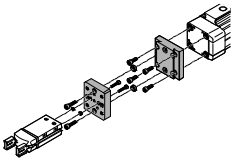
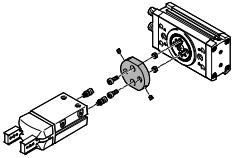
| Permissible drive/gripper combinations with adapter kit | | | | | Download CAD data → www.festo.com | | |
|---|-------------------------------------|---------|---|---|--|------------------|---------------------------|
| Combination | Drive | Gripper | Mounting option | | CRC ¹⁾ | Part No. | Type |
| | | |  |  | | | |
| | | | Size | Size | | | |
| DGP..., DGE..., DGEA/DHRS | DG... | DHRS | | | | HMVA, HAPG, HMSV | |
|  | Direct mounting | | | | | | |
| | 18 ²⁾ , 25 ³⁾ | 10 | ■ | ■ | 2 | 196788 | HMVA-DLA18/25 |
| | | | | | | 192706 | HAPG-37-S1 |
| | 40 ³⁾ | 10 | ■ | ■ | | 196790 | HMVA-DLA40 |
| | | | | | | 192706 | HAPG-37-S1 |
| | 18 ²⁾ , 25 ³⁾ | 16 | ■ | ■ | | 196788 | HMVA-DLA18/25 |
| | | | | | | 192705 | HAPG-36-S1 |
| | 40 ³⁾ | 16 | ■ | ■ | | 196790 | HMVA-DLA40 |
| | | | | | | 192705 | HAPG-36-S1 |
| | 18 ²⁾ , 25 ³⁾ | 25 | ■ | ■ | | 196788 | HMVA-DLA18/25 |
| | | | | | | 193922 | HAPG-37-S4 |
| | 40 ³⁾ | 25 | ■ | ■ | | 196790 | HMVA-DLA40 |
| | | | | | | 193922 | HAPG-37-S4 |
| | Dovetail mounting | | | | | | |
| | 18 ²⁾ , 25 | 16 | ■ | ■ | 2 | 196788 | HMVA-DLA18/25 |
| | | | | | | 177767 | HMSV-27 |
| | 40 | 16 | ■ | ■ | | 196790 | HMVA-DLA40 |
| | | | | | | 177767 | HMSV-27 |
| 18 ²⁾ , 25 | 25 | ■ | ■ | 196788 | | HMVA-DLA18/25 | |
| | | | | 177768 | | HMSV-28 | |
| 40 | 25 | ■ | ■ | 196790 | | HMVA-DLA40 | |
| | | | | 177768 | | HMSV-28 | |
| 40 | 32 | ■ | ■ | 196790 | | HMVA-DLA40 | |
| | | | | 177769 | | HMSV-29 | |
| 40 | 40 | ■ | ■ | 196790 | | HMVA-DLA40 | |
| | | | | 177770 | | HMSV-30 | |
| DRRD/DHRS | DRRD | DHRS | | | | DHAA | |
|  | 8 | 10 | ■ | ■ | 2 | 2816591 | DHAA-G-Q11-8-B2/B3-10 |
| | 10 | 10 | ■ | ■ | | 2816068 | DHAA-G-Q11-10-B2/B3-10 |
| | 12 | 10 | ■ | ■ | | 2814790 | DHAA-G-Q11-12-B2/B3-10 |
| | 12 | 16 | ■ | ■ | | 2811183 | DHAA-G-Q11-12-B2/B3-16 |
| | 16 | 16 | ■ | ■ | | 1979085 | DHAA-G-Q11-16-B2/B3-16 |
| | 16 | 25 | ■ | ■ | | 1978889 | DHAA-G-Q11-16-B2/B3-25 |
| | 20 | 25 | ■ | ■ | | 1978443 | DHAA-G-Q11-20-B2/B3-25 |
| | 20 | 32 | ■ | ■ | | 1979912 | DHAA-G-Q11-20-B2/B3-32 |
| | 25 | 25 | ■ | ■ | | 1801802 | DHAA-G-Q11-25-B2/B3-25 |
| | 25 | 32 | ■ | ■ | | 1802969 | DHAA-G-Q11-25-B2/B3-32 |
| | 32 | 32 | ■ | ■ | | 1979992 | DHAA-G-Q11-32-B2/B3-32 |
| | 32 | 40 | ■ | ■ | | 1980014 | DHAA-G-Q11-32-B2/B3-40 |
| | 35, 40 | 40 | ■ | ■ | | 1980059 | DHAA-G-Q11-35/40-B2/B3-40 |

1) Corrosion resistance class CRC 2 to Festo standard FN 940070
Moderate corrosion stress. Indoor applications in which condensation may occur. External visible parts with primarily decorative requirements for the surface and which are in direct contact with the ambient atmosphere typical for industrial applications.

2) Only for DGEA-...

3) Only for DGE.../DGP

Radial grippers DHRS

Accessories



Adapter kit
DHAA, HAPG

Material:
Wrought aluminium alloy
Free of copper and PTFE
RoHS-compliant

 Note
The kit includes the individual mounting interface as well as the necessary mounting material.

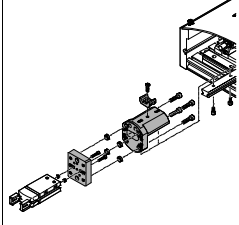
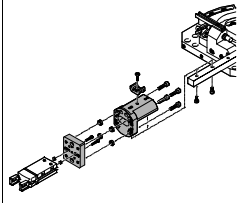
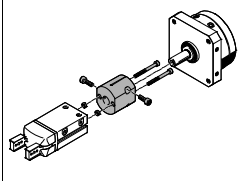
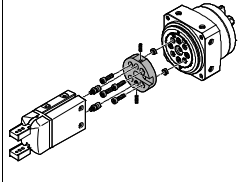
| Permissible drive/gripper combinations with adapter kit | | | | | | Download CAD data → www.festo.com | |
|---|------------|---------|-----------------|--------|-------------------|--|---------------------|
| Combination | Drive | Gripper | Mounting option | | Adapter kit | | |
| | | | Size | Size | CRC ¹⁾ | Part No. | Type |
| | | | | | | | |
| HSP/DHRS | HSP | DHRS | | | HAPG | | |
|  | 12 | 10 | ■ | – | 2 | 192709 | HAPG-60-S1 |
| | | | | | | 540881 | HAPG-70-B |
| | 16 | 10 | ■ | – | | 192706 | HAPG-37-S1 |
| | | | | | | 540882 | HAPG-71-B |
| | 16 | 16 | ■ | – | | 192705 | HAPG-36-S1 |
| | | | | 540882 | HAPG-71-B | | |
| | 25 | 16 | ■ | – | 192705 | HAPG-36-S1 | |
| | | | | | 540883 | HAPG-72-B | |
| | 25 | 25 | ■ | – | 193922 | HAPG-37-S4 | |
| | | | | | 540883 | HAPG-72-B | |
| HSW/DHRS | HSW | DHRS | | | HAPG | | |
|  | 12, 16 | 10 | ■ | – | 2 | 192706 | HAPG-37-S1 |
| | | | | | | 540882 | HAPG-71-B |
| | 12, 16 | 16 | ■ | – | | 192705 | HAPG-36-S1 |
| | | | | | 540882 | HAPG-71-B | |
| DSM/DHRS | DSM-...-FW | DHRS | | | HAPG | | |
|  | 6, 8, 10 | 10 | ■ | ■ | 2 | 187568 | HAPG-34 |
| | DSM-... | DHRS | | | HAPG | | |
| | 12 | 16 | ■ | ■ | 2 | 163266 | HAPG-17 |
| | 16 | 16 | ■ | ■ | | 163267 | HAPG-18 |
| | 16 | 25 | ■ | ■ | | 163268 | HAPG-19 |
| | 25 | 25 | ■ | ■ | | 163269 | HAPG-20 |
| | 25 | 32 | ■ | ■ | | 163270 | HAPG-21 |
| | 32 | 32 | ■ | ■ | | 163271 | HAPG-22 |
| DSM-...-HD/DHRS | DSM-...-HD | DHRS | | | | DHAA | |
|  | 12 | 16 | ■ | ■ | 2 | 8072157 | DHAA-G-R3-12-B18-10 |
| | 12 | 10 | ■ | ■ | | 8072172 | DHAA-G-R3-12-B20-10 |
| | 16 | 16 | ■ | ■ | | 8071917 | DHAA-G-R3-16-B18-10 |
| | 16 | 25 | ■ | ■ | | 8079173 | DHAA-G-R3-16-B18-16 |
| | 25 | 25 | ■ | ■ | | 8071956 | DHAA-G-R3-25-B18-16 |
| | 25 | 32 | ■ | ■ | | 8079201 | DHAA-G-R3-25-B20-32 |
| | 32 | 32 | ■ | ■ | | 8079208 | DHAA-G-R3-32-B18-25 |
| | 32 | 40 | ■ | ■ | | 8079212 | DHAA-G-R3-32-B20-40 |

1) Corrosion resistance class CRC 2 to Festo standard FN 940070
Moderate corrosion stress. Indoor applications in which condensation may occur. External visible parts with primarily decorative requirements for the surface and which are in direct contact with the ambient atmosphere typical for industrial applications.

Radial grippers DHRS



Accessories



Adapter kit
HAPG, HMSV

Material:
Wrought aluminium alloy
Free of copper and PTFE
RoHS-compliant

 Note
The kit includes the individual mounting interface as well as the necessary mounting material.

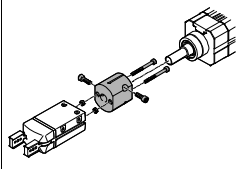
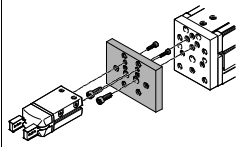
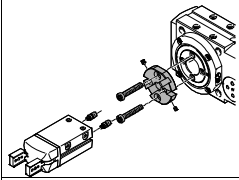
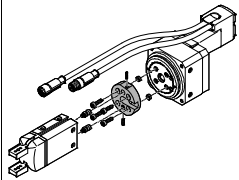
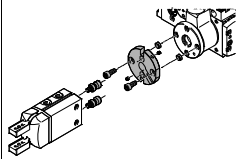
| Permissible drive/gripper combinations with adapter kit | | | | | | Download CAD data → www.festo.com | |
|---|-------------|-------------|---|---|-------------------|--|----------------------------|
| Combination | Drive | Gripper | Mounting option | | CRC ¹⁾ | Part No. | Type |
| | | |  |  | | | |
| DSL/DHRS | DSL | DHRS | | | HAPG | | |
|  | 16 | 16 | ■ | ■ | 2 | 163266 | HAPG-17 |
| | 20 | 16 | ■ | ■ | | 163267 | HAPG-18 |
| | 20 | 25 | ■ | ■ | | 163268 | HAPG-19 |
| | 25 | 25 | ■ | ■ | | 163269 | HAPG-20 |
| | 25 | 32 | ■ | ■ | | 163270 | HAPG-21 |
| | 32 | 32 | ■ | ■ | | 163271 | HAPG-22 |
| EGSL/DHRS | EGSL | DHRS | | | HMSV | | |
|  | 35 | 10 | ■ | ■ | 2 | 548784 | HMSV-54 |
| | 45, 55 | 16 | ■ | ■ | | 1088262 | HMSV-70 |
| | 75 | 25, 32 | ■ | ■ | | 548785 | HMSV-55 |
| | | | | | | 548786 | HMSV-56 |
| ERMB/DHRS | ERMB | DHRS | | | HAPG | | |
|  | 20 | 25 | ■ | ■ | 2 | 184479 | HAPG-SD2-3 |
| | 25 | 25 | ■ | ■ | | 184482 | HAPG-SD2-6 |
| | 20 | 32 | ■ | ■ | | 184480 | HAPG-SD2-4 |
| | 25 | 32 | ■ | ■ | | 184483 | HAPG-SD2-7 |
| | 32 | 32 | ■ | ■ | | 184485 | HAPG-SD2-9 |
| | 32 | 40 | ■ | ■ | | 184486 | HAPG-SD2-10 |
| ERMO/DHRS | ERMO | DHRS | | | DHAA | | |
|  | 12 | 16 | ■ | ■ | 2 | 8072157 | DHAA-G-R3-12-B18-10 |
| | 12 | 10 | ■ | ■ | | 8072172 | DHAA-G-R3-12-B20-10 |
| | 16 | 16 | ■ | ■ | | 8071917 | DHAA-G-R3-16-B18-10 |
| | 16 | 25 | ■ | ■ | | 8079173 | DHAA-G-R3-16-B18-16 |
| | 25 | 25 | ■ | ■ | | 8071956 | DHAA-G-R3-25-B18-16 |
| | 25 | 32 | ■ | ■ | | 8079201 | DHAA-G-R3-25-B20-32 |
| | 32 | 32 | ■ | ■ | | 8079208 | DHAA-G-R3-32-B18-25 |
| | 32 | 40 | ■ | ■ | | 8079212 | DHAA-G-R3-32-B20-40 |
| EHMB/DHRS | EHMB | DHRS | | | HAPG | | |
|  | 20 | 32 | ■ | ■ | 2 | 184485 | HAPG-SD2-9 |
| | 20 | 40 | ■ | ■ | | 184486 | HAPG-SD2-10 |
| | 25, 32 | 40 | ■ | ■ | | 526027 | HAPG-SD2-21 |

1) Corrosion resistance class CRC 2 to Festo standard FN 940070

Moderate corrosion stress. Indoor applications in which condensation may occur. External visible parts with primarily decorative requirements for the surface and which are in direct contact with the ambient atmosphere typical for industrial applications.

Radial grippers DHRS

Accessories

FESTO

| Ordering data | | | | | | |
|---|---------------|--|------------|---------------|---------------|------------------|
| | For size [mm] | Description | Weight [g] | Part No. | Type | PU ¹⁾ |
| Centring sleeve ZBH Technical data → Internet: zbh | | | | | | |
|  | 10, 16 | For centring the gripper during mounting | 1 | 189652 | ZBH-5 | 10 |
| | 25 | | 1 | 186717 | ZBH-7 | |
| | 32 | | 1 | 150927 | ZBH-9 | |
| | 40 | | 1 | 189653 | ZBH-12 | |

1) Packaging unit

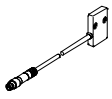
| Ordering data | | | | | | |
|---|----------|------------|---------------|---------------------|--|--|
| Type | For size | Weight [g] | Part No. | Type | | |
| Position sensor SMH-S1 Technical data → Internet: smh-s1 | | | | | | |
|  | 10 | 20 | 175712 | SMH-S1-HGR10 | | |

Signal converter SVE4 for position sensor SMH-S1

- Converts analogue signals into switching points
- Switching function freely programmable with teach-in
- Threshold value, hysteresis or window comparator

| Ordering data | | | | | | |
|--|----------|--------------------|-------------------|------------------|------------|--|
| Type | For size | Input connection | Output connection | Switching output | Weight [g] | Part No. Type |
| Signal converter SVE4 Technical data → Internet: sve4 | | | | | | |
|  | 10 | Socket M8x1, 4-pin | Plug M8x1, 4-pin | 2x PNP | 19 | 544216 SVE4-HS-R-HM8-2P-M8 |
| | | | | 2x NPN | | 544219 SVE4-HS-R-HM8-2N-M8 |

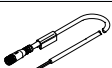
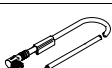
| Ordering data – Connecting cables | | | | | | Technical data → Internet: nebu |
|---|------------------------------|------------------------------|------------------|---------------|-----------------------------|---------------------------------|
| | Electrical connection, left | Electrical connection, right | Cable length [m] | Part No. | Type | |
| Connection between position sensor and signal converter | | | | | | |
|  | Straight socket, M8x1, 4-pin | Straight plug, M8x1, 4-pin | 2.5 | 554035 | NEBU-M8G4-K-2.5-M8G4 | |
| | | | | | | |
| Connection between signal converter and controller | | | | | | |
|  | Straight socket, M8x1, 4-pin | Cable, open end, 4-wire | 2.5 | 541342 | NEBU-M8G4-K-2.5-LE4 | |
| | | | 5 | 541343 | NEBU-M8G4-K-5-LE4 | |
|  | Angled socket, M8x1, 4-pin | Cable, open end, 4-wire | 2.5 | 541344 | NEBU-M8W4-K-2.5-LE4 | |
| | | | 5 | 541345 | NEBU-M8W4-K-5-LE4 | |



Radial grippers DHRS

Accessories

FESTO

Proximity sensor for size 16 ... 40

| Ordering data – Proximity sensors for T-slot, magneto-resistive | | | | | | Technical data → Internet: smt | |
|---|-----------------------------------|---|------------------|------------------|----------|--------------------------------|--|
| | Type of mounting | Electrical connection, connection direction | Switching output | Cable length [m] | Part No. | Type | |
| N/O contact | | | | | | | |
|  | Insertable in the slot lengthwise | Cable, 3-wire, lateral | PNP | 2.5 | 547859 | SMT-8G-PS-24V-E-2,5Q-OE | |
| | | Plug M8x1, 3-pin, lateral | | 0.3 | 547860 | SMT-8G-PS-24V-E-0,3Q-M8D | |
| | | Cable, 3-wire, lateral | NPN | 2.5 | 8065028 | SMT-8G-NS-24V-E-2,5Q-OE | |
| | | Plug M8x1, 3-pin, lateral | | 0.3 | 8065027 | SMT-8G-NS-24V-E-0,3Q-M8D | |

| Ordering data – Connecting cables | | | | | Technical data → Internet: nebu | |
|---|------------------------------|------------------------------|------------------|----------|---------------------------------|--|
| | Electrical connection, left | Electrical connection, right | Cable length [m] | Part No. | Type | |
|  | Straight socket, M8x1, 3-pin | Cable, open end, 3-wire | 2.5 | 541333 | NEBU-M8G3-K-2.5-LE3 | |
| | | | 5 | 541334 | NEBU-M8G3-K-5-LE3 | |
|  | Angled socket, M8x1, 3-pin | Cable, open end, 3-wire | 2.5 | 541338 | NEBU-M8W3-K-2.5-LE3 | |
| | | | 5 | 541341 | NEBU-M8W3-K-5-LE3 | |

Position transmitter

The position transmitter continuously senses the position of the piston.
It has an analogue output with an output signal in proportion to the piston position.

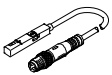
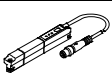
| Ordering data – Position transmitters for T-slot | | | | | | | Technical data → Internet: position transmitter | | |
|---|-----------|--------------------------|-----------------|----------|-------------------------------|---------------------------|---|----------|-----------------------------|
| | For size | Position measuring range | Analogue output | | Type of mounting | Electrical connection | Cable length [m] | Part No. | Type |
| | | | [V] | [mA] | | | | | |
|  | 16 ... 40 | 0 ... 40 | 0 ... 10 | – | Insertable in slot from above | Plug M8x1, 4-pin, in-line | 0.3 | 553744 | SMAT-8M-U-E-0,3-M8D |
|  | 32, 40 | 0 ... 50 | – | 4 ... 20 | Insertable in slot from above | Plug M8x1, 4-pin, in-line | 0.3 | 1531265 | SDAT-MHS-M50-1L-SA-E-0,3-M8 |

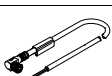
| Ordering data – Connecting cables | | | | | Technical data → Internet: nebu | |
|---|------------------------------|------------------------------|------------------|----------|---------------------------------|--|
| | Electrical connection, left | Electrical connection, right | Cable length [m] | Part No. | Type | |
|  | Straight socket, M8x1, 4-pin | Cable, open end, 4-wire | 2.5 | 541342 | NEBU-M8G4-K-2.5-LE4 | |
| | | | 5 | 541343 | NEBU-M8G4-K-5-LE4 | |
|  | Angled socket, M8x1, 4-pin | Cable, open end, 4-wire | 2.5 | 541344 | NEBU-M8W4-K-2.5-LE4 | |
| | | | 5 | 541345 | NEBU-M8W4-K-5-LE4 | |

Festo North America

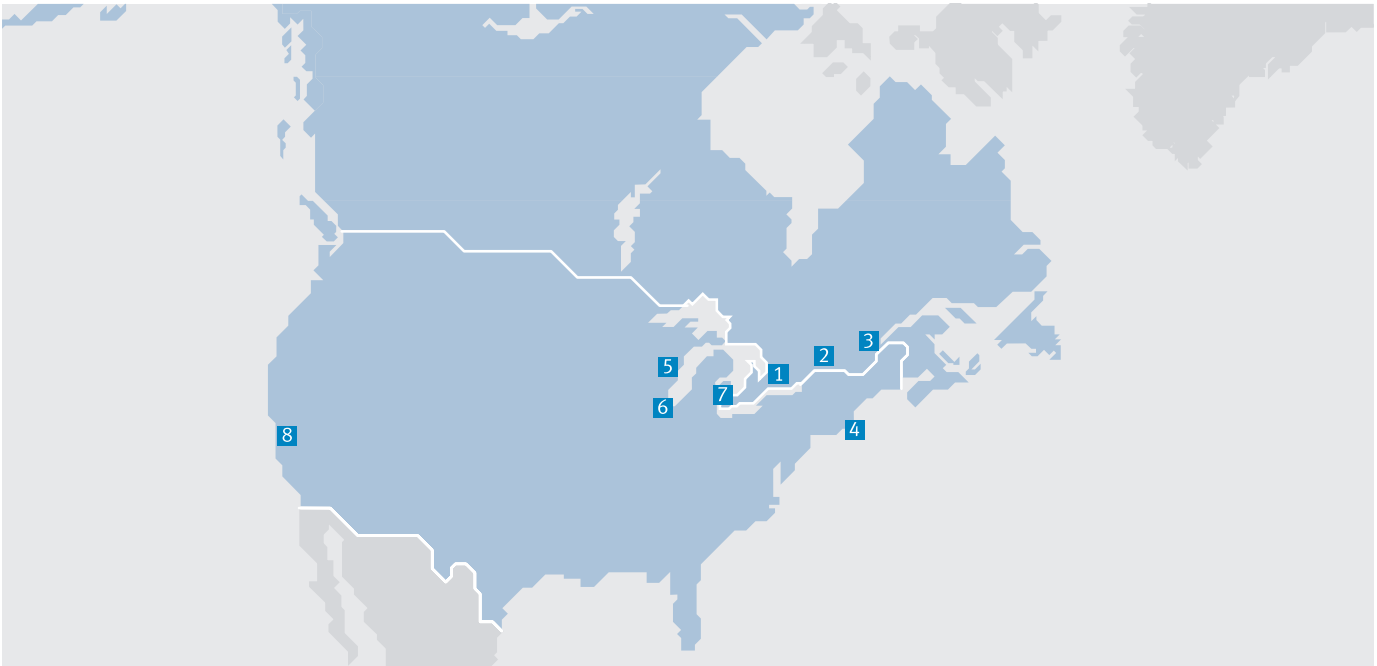

**1 Festo Canada
Headquarters
Festo Inc.**
5300 Explorer Drive
Mississauga, ON
L4W 5G4

2 Montréal
5600, Trans-Canada
Pointe-Claire, QC
H9R 1B6

3 Québec City
2930, rue Watt#117
Québec, QC
G1X 4G3



**4 Festo United States
Headquarters
Festo Corporation**
395 Moreland Road
Hauppauge, NY
11788

5 Appleton
North 922 Tower View Drive, Suite N
Greenville, WI
54942

7 Detroit
1441 West Long Lake Road
Troy, MI
48098

6 Chicago
85 W Algonquin - Suite 340
Arlington Heights, IL
60005

8 Silicon Valley
4935 Southfront Road, Suite F
Livermore, CA
94550

Festo Regional Contact Center

Canadian Customers

Commercial Support:
Tel: 1 877 GO FESTO (1 877 463 3786)
Fax: 1 877 FX FESTO (1 877 393 3786)
Email: festo.canada@ca.festo.com

Technical Support:
Tel: 1 866 GO FESTO (1 866 463 3786)
Fax: 1 877 FX FESTO (1 877 393 3786)
Email: technical.support@ca.festo.com

USA Customers

Commercial Support:
Tel: 1 800 99 FESTO (1 800 993 3786)
Fax: 1 800 96 FESTO (1 800 963 3786)
Email: customer.service@us.festo.com

Technical Support:
Tel: 1 866 GO FESTO (1 866 463 3786)
Fax: 1 800 96 FESTO (1 800 963 3786)
Email: product.support@us.festo.com